

ANYRIDGE[®]

by MEGA'GEN



What is the **AnyRidge** way?

For clinicians...

less invasive, fast,
simple, predictable,
& esthetically
superior implant
treatment

Realising the **ONE-DAY Implant™**

For patients...

strong new
esthetic &
functional teeth via
painless & rapid
treatment

AnyRidge does it right!

AnyRidge goes FAR BEYOND standard expectations of dental implants...

The key benefits of AnyRidge implants become evident when considering immediate loading...

With the new loading protocol developed based on clinical results with AnyRidge, your patients have new smiles faster than ever....

- Guaranteed excellent stability, even with compromised bone density
- Less reduction & more preservation of cortical bone
- Wider implant possibilities than crestal width
- Clinically proven safety
- Faster & stronger osseointegration
- Esthetic design & varied abutment selection
- Super implant-prosthetic connection
- Innovative R2GATE software for completing implant & prosthesis in ONE DAY

AnyRidge – a new design standard on the global stage

Launched in 2009 as a biologically-inspired implant concept, AnyRidge consistently surpasses clinical benchmarks

AnyRidge

Have you made the
PARADIGM SHIFT yet?
Do it the **AnyRidge** way!



Key Advantages

Excellent initial stability even at the compromised bone density

No screw loosening guaranteed!

Unique and valuable ISQ pattern; essential for predictable immediate or early loading.



004 Characteristics & Advantages

- 004 I. Design Concept
- 006 II. Surgery
- 007 III. Prosthetics
- 010 IV. Maintenance

011 Fixture Product & Packaging

- 011 I. Dimension
- 012 II. Fixture Size
- 016 III. Packaging

017 Cover Screw & Healing Abutment

018 Abutment & Prosthetic options

- 018 I. Fixture level Prosthesis
 - 026 1. Extra EZ Post
- 034 II. Abutment level Prosthesis
 - 034 1. Solid Abutment & Components
 - 038 2. Octa Abutment & Components
 - 043 3-1. Multi-unit Abutment & Components
 - 059 3-2. Multi-unit Abutment & Components
 - 063 4. Flat Abutment & Components
- 066 III. Overdenture Prosthesis
 - 066 1. MegaGen Overdenture System
 - 067 2. Meg-Loc Abutment & Component
 - 070 3. Meg-Ball Abutment & Component
 - 073 4. Meg-Magnet Abutment & Component
 - 076 5. Meg-Rhein Abutment & Components

082 AnyRidge Kit

- 082 I. Abutment Selection Guide Kit
- 083 II. Surgical Kit
- 089 III. Prosthetic Kit
- 091 IV. Bone Profiler Kit
- 092 V. Optional components

094 R2GATE Full Surgical KIT

- 094 I. R2GATE Full Surgical Kit

100 R2GATE Universal Kit

106 Digital Material

- 106 I. ZrGEN
- 106 II. TiGEN

121 Clinical Cases

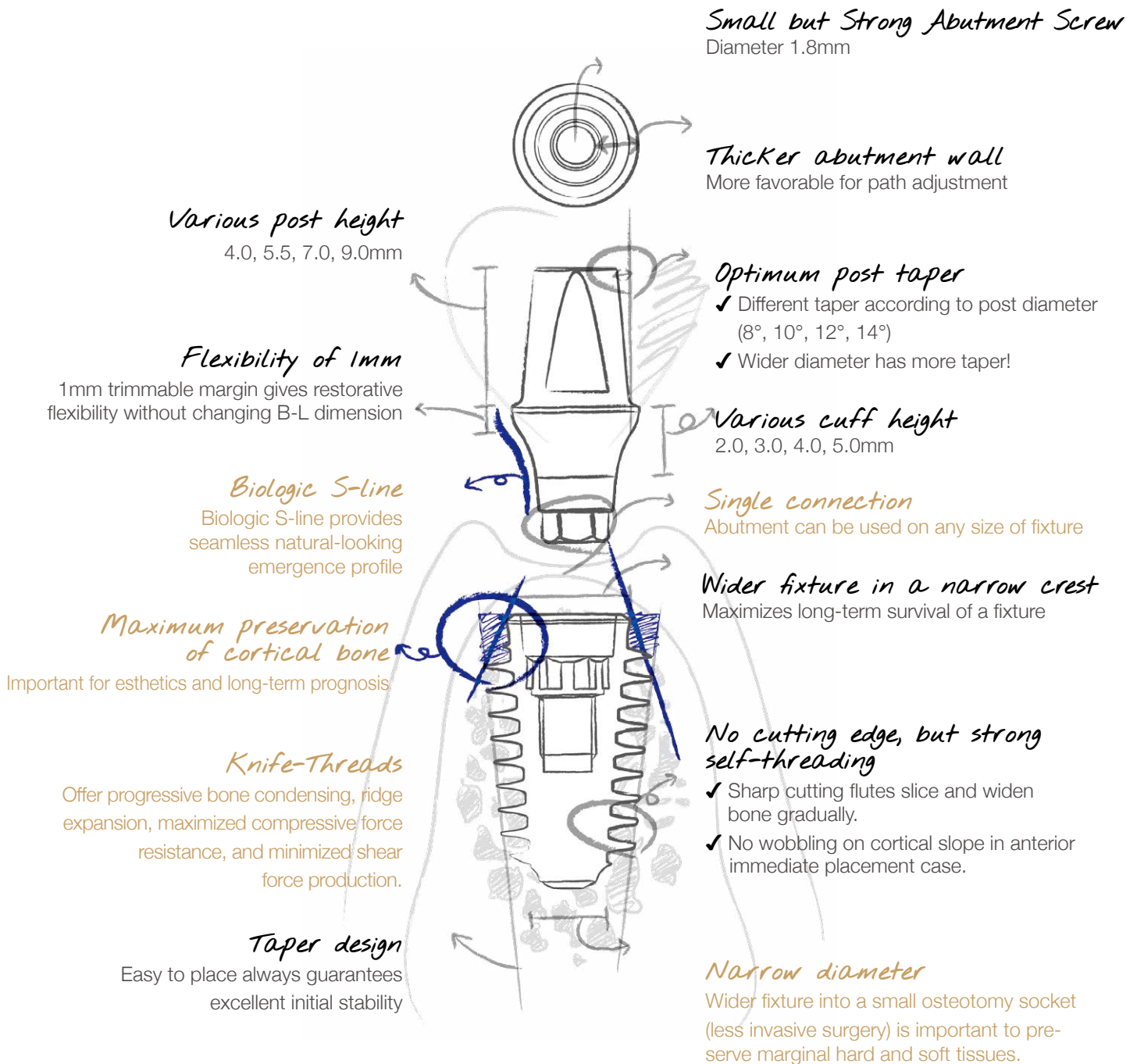

Characteristics & Advantages

I. Design Concept



AnyRidge Fixture Line up

Same core diameter, but different thread depth

Core Diameter	Fixture Diameter									
	Ø3.5	Ø4.0	Ø4.5	Ø5.0	Ø5.5	Ø6.0	Ø6.5	Ø7.0	Ø7.5	Ø8.0
Ø2.8										
Thread depth	0.3									
Ø3.3										
Thread depth		0.35	0.6	0.85	1.1					
Ø3.8										
Thread depth			0.35	0.6	0.85					
Ø4.0										
Thread depth				0.45	0.7	0.95				
Ø4.3										
Thread depth				0.35	0.6	0.85				
Ø4.8										
Thread depth					0.35	0.6	0.85	1.1	1.35	1.6

II. Surgery

Excellent initial stability, even at compromised bone density.
AnyRidge® Fixture cuts bone smoothly and condenses it simultaneously.

1. Fixture placement

• Soft bone

The super self-tapping threads have a single core diameter that facilitates minimal site preparation by utilizing a smaller osteotomy to place a wider fixture with special threads.

• Hard bone

AnyRidge® Fixture with its super self-tapping thread design is easier than other traditional implants at hard bone.

**Caution! : The osteotomy socket (drilling) size should almost reach the size of fixture to avoid getting stuck in the bone during placement.*

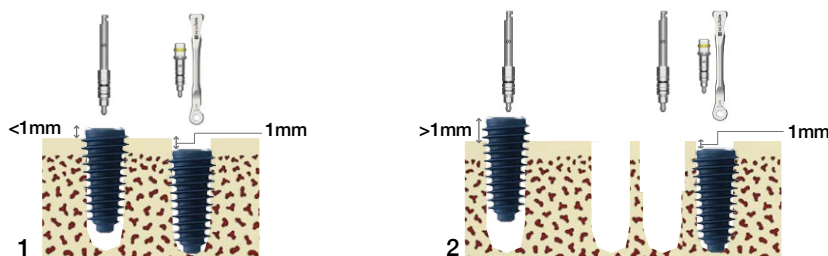

Easy way to avoid stuck in the bone during AnyRidge implant placement

1. Due to extremely strong initial stability of AnyRidge fixture, it can be stuck in the middle during placement especially in mandibular hard bone. Please consider 'One millimeter Rule' to avoid this in the best and easiest way. Clinician can customize the drilling sequence once he fully understand the concept and characteristics of AnyRidge system to get preferred initial stability. 'One millimeter Rule' is simple; if an implant engine (40Ncm) stops leaving one millimeter above the crest, use ratchet wrench to screw it down to preferred position. We recommended to place implant platform 0.5~1.0mm under the crest.

2. If a fixture sticks in the middle leaving more than 1mm above the crest in hard mandibular bone, it is recommended to remove it using a wrench rather than trying to screw it down with excessive torque. Please use a cortical bone drill that is included in a surgical kit, the depth of cortical bone drilling can be adjusted according to the bone condition. Then, place the same fixture into the osteotomy socket.

2. Customized drilling Sequence

- AnyRidge® system has no fixed drilling protocol, just make your own protocol based on patient's bone quality to attain preferred initial stability or simply drill an osteotomy socket to given conditions and then decide the diameter of a fixture.

Example 1) Ø5.0mm fixture can be placed 2.9mm osteotomy socket in D4 bone. Excellent initial stability can be attained



Example 2) In hard one, it is highly recommended to make a socket almost same diameter size as a fixture

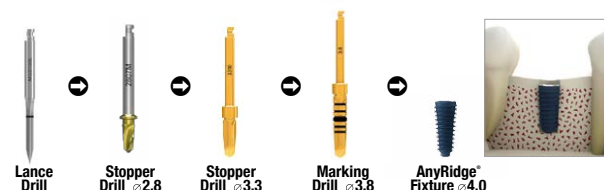

- Improved drill design has simplified drilling sequence, you can even harvest autogenous bone using these specially designed drills.
(Recommended speed : 50 RPM, 50 Ncm with saline solution irrigation)
- The best way to get ideal initial stability with AnyRidge system is placing a fixture using a surgical engine, leaving one or two treads above the crest; then use ratchet wrench to place the platform at the desired position.

III. Prosthetics

Better esthetic outcomes from wide variety of prosthetic options!
 Stop worrying about screw loosening!

1. No screw loosening, less biologic width!

• Magic Five (5° Internal connection)

Now you can be free from screw loosening with our unique connection (5 degree morse taper) which gives perfect hermetic sealing. Biologic width is minimized due to no micro gap, and crestal bone health is well maintained.

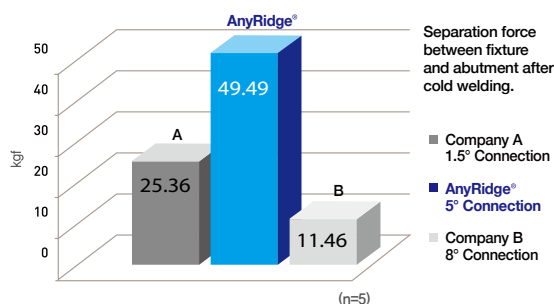

Performed Retention Test to evaluate the fixture-abutment retention force using Universal Testing Machine -R&D center in MegaGen Implant Co.,Ltd.(2009)-

2. Biologic S-line

Helps to achieve beautiful, natural-looking esthetics.

3. Optimum hex height

Feel AnyRidge connection. It starts with impression taking and lasts until final restoration.

4. All indications, various abutment options

Every case, every shape, every size. Everything was considered to satisfy every need.

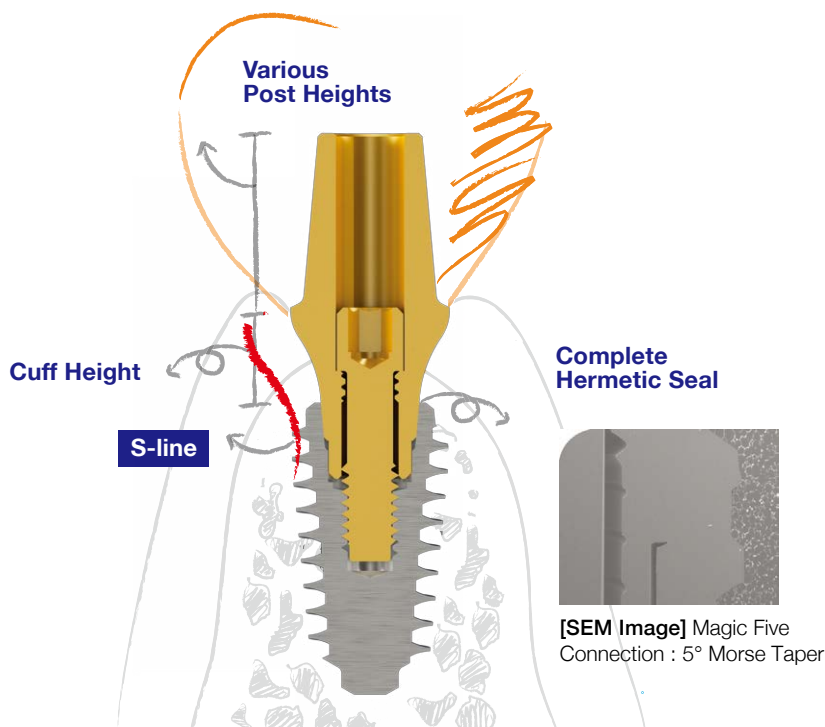

► Two different connections between a fixture & a component

1. All transitional and temporary components have 'Ledges' on the bottom

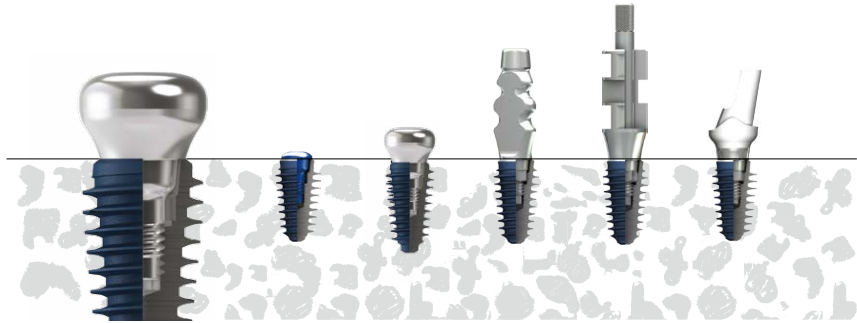

- Cover Screws, Healing Abutments, Impression Coping (transfer and pick-up type), Temporary Cylinders have ledges on the bottom which prevent from cold welding with a fixture.
- Hand Drivers(1.2 Hex) or Impression Drivers can be used easily to screw these components in and out.

2. All permanent abutments will make strong connections with fixtures, even with finger force!

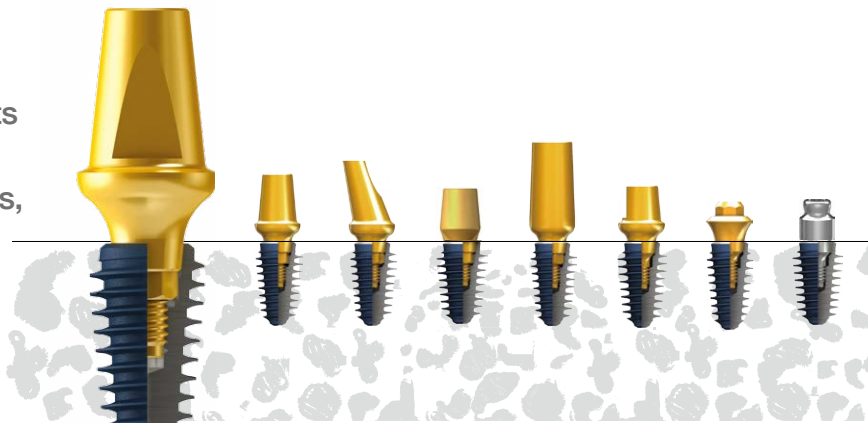

- 25~35Ncm is recommended to connect a permanent abutment into a fixture.
- A fixed abutment cannot be removed with finger force even after complete removal of Abutment Screw because of perfect cold welding. To remove a permanent abutment, Abutment Removal Driver should be used.

► How to remove Permanent Abutment from Fixture?

Due to extremely strong connection force, you don't have to worry about screw loosening. Please use our special 'removal driver' when you want to remove an abutment from a fixture.

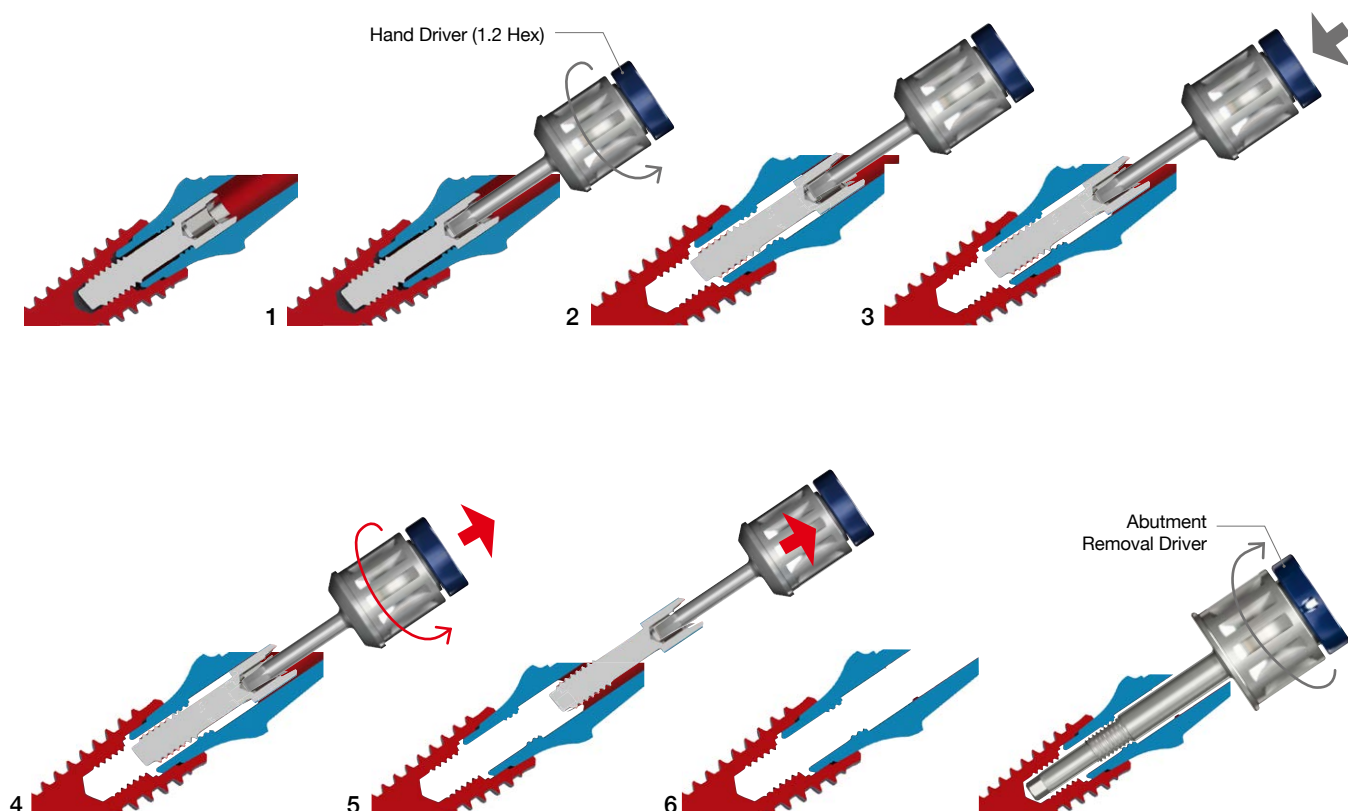

1. Use a Hand Driver(1.2 Hex) to unscrew Abutment Screw.
2. Continue to turn counter-clockwise until you feel a click of disengagement.
3. Push down Hand Driver once again to catch and fix Abutment Screw.
4. Lift up Hand Driver lightly and continue to turn counter-clockwise until Abutment Screw engages with the inner screw of Abutment.
5. Remove Abutment Screw completely from the abutment
6. Insert an 'Abutment Removal Driver' and continue to turn clockwise until the abutment comes out of fixture. You can feel some resistance during screw-down of the Abutment Removal Driver, but don't worry, simple exert is needed disconnect the abutment from the fixture.

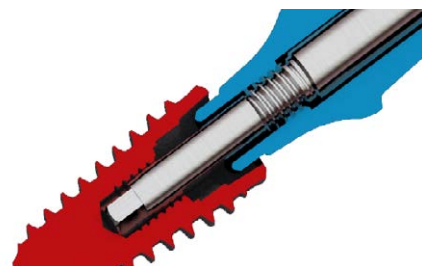

IV. Maintenance

Unique and sturdy design provides long-term stability!

1. Higher cortical bone preservation is guaranteed



AnyRidge does not depend on cortical bone for initial stability; decreased stress on cortical bone helps to prevent bone resorption after implantation.

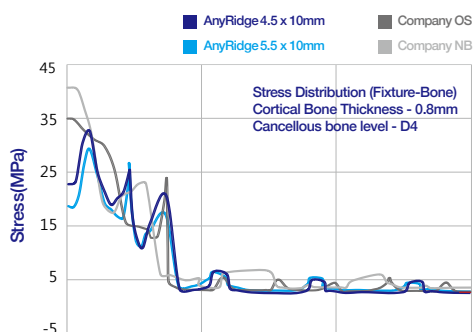

Performed Finite element analysis to evaluate the fixture-bone stress using ABAQUS 6.8 -R&D center in MegaGen Implant Co.,Ltd.(2009)-

- More cortical bone
- = More soft tissue volume
- = Beautiful gingival line

Advanced coronal design allows maximum cortical bone preservation around implants. Beyond osseointegration, AnyRidge can assure beautiful gingival line by preserving and maintaining more cortical bone.

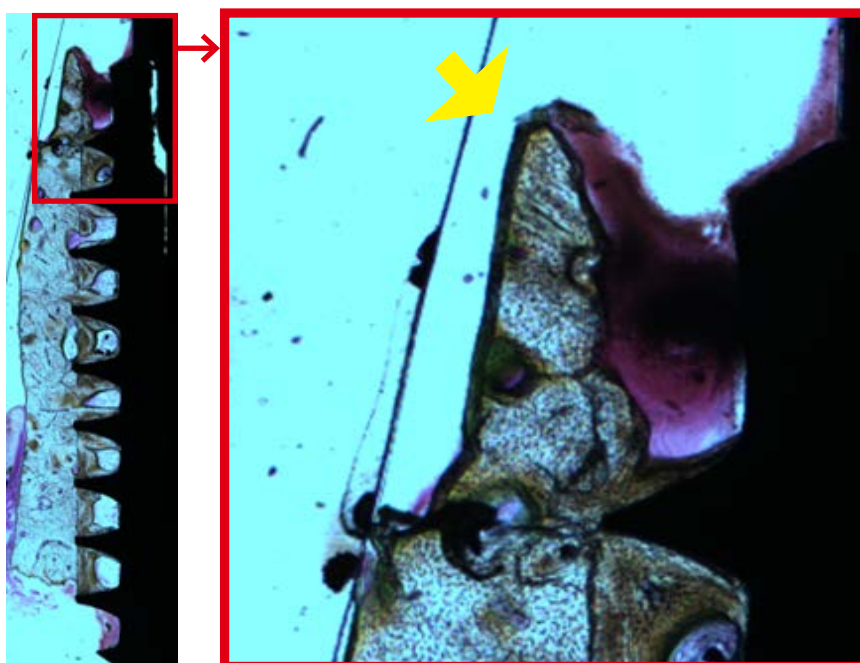

• A Human Biopsy (2.5 yrs after placement)

The sharp and high alveolar crest (yellow arrow) could be maintained due to biology driven implant design. With this maintenance of alveolar bone, the peri-implant marginal gingiva showed almost no recession during 2.5 years of follow-up, even in the case of limited ridge width.



Fixture Product & Packaging

I. Dimension

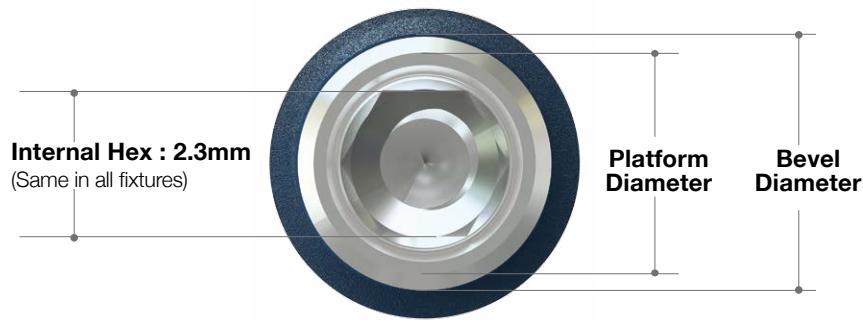

Core (mm)	Platform (mm)	Bevel (mm)
Ø3.3	3.5	3.8
		4.0
Ø3.8	4.0	4.5
Ø4.0	4.25	4.75
Ø4.3	4.5	5.0
Ø4.8	5.0	5.5

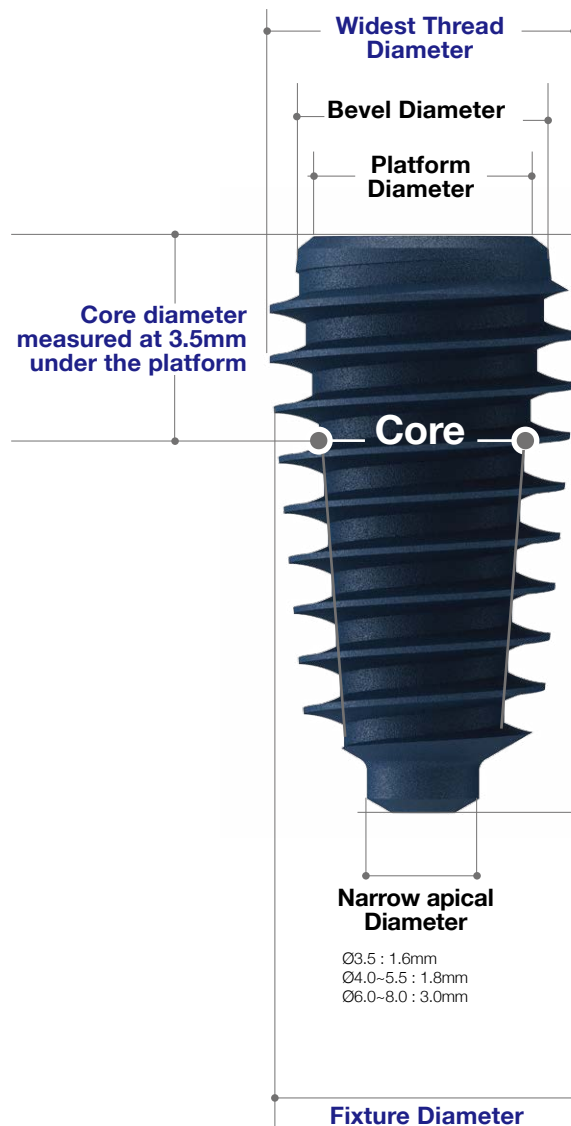

Widest thread diameter is
0.5mm wider than fixture size at 3.5mm
0.4mm wider than fixture size at 4.0-8.0mm

**For example*
Ø3.5 = Fixture diameter + 0.5mm
Ø4.0-Ø8.0 = Fixture diameter + 0.4mm

Length

**Actual length of fixture*
Core Ø3.3-4.3 fixture : 0.8mm shorter than the written length
Core Ø4.8 fixture : 0.6mm shorter than the written length

Important concept!

It has been proven that 0.5-1.0mm subcrestal placement shows better crestal bone response. With AnyRidge system, a fixture goes down to the ideal position without further drilling avoiding damage to important anatomic structures.

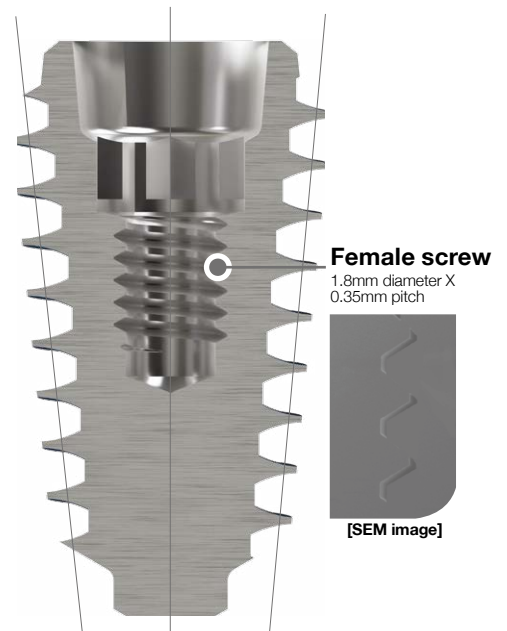

II. Fixture Size

Small Ø3.5

- Cover Screw included.

- Availability of 7mm product is subject to local approval.

Fixture Diameter (mm)	Core (mm)	Length (mm)	Ref.C
3.5	2.8	7	FANIHX3507C
		8.5	FANIHX3508C
		10	FANIHX3510C
		11.5	FANIHX3511C
		13	FANIHX3513C
		15	FANIHX3515C



Regular Ø4.0

- Cover Screw included.

- Availability of 7mm product is subject to local approval.

Fixture Diameter (mm)	Core (mm)	Length (mm)	Ref.C
4.0	3.3	7	FANIHX4007C
		8.5	FANIHX4008C
		10	FANIHX4010C
		11.5	FANIHX4011C
		13	FANIHX4013C
		15	FANIHX4015C



Regular Ø4.5

- Cover Screw included.

- Availability of 7mm product is subject to local approval.

Fixture Diameter (mm)	Core (mm)	Length (mm)	Ref.C
4.5	3.3	7	FANIHX4507C
		8.5	FANIHX4508C
		10	FANIHX4510C
		11.5	FANIHX4511C
		13	FANIHX4513C
		15	FANIHX4515C
	3.8	7	AR384507C
		8.5	AR384508C
		10	AR384510C
		11.5	AR384511C
		13	AR384513C
		15	AR384515C



➔ Fixture Size (Continued)

Wide Ø5.0

- Cover Screw included.



Fixture Diameter (mm)	Core (mm)	Length (mm)	Ref.C
5.0	3.3	7	FANIH5007C
		8.5	FANIH5008C
		10	FANIH5010C
		11.5	FANIH5011C
		13	FANIH5013C
	3.8	7	AR385007C
		8.5	AR385008C
		10	AR385010C
		11.5	AR385011C
		13	AR385013C
		15	AR385015C

Fixture Diameter (mm)	Core (mm)	Length (mm)	Ref.C
5.0	4.0	7	FANIH5007SC
		8.5	FANIH5008SC
		10	FANIH5010SC
		11.5	FANIH5011SC
		13	FANIH5013SC
	4.3	7	AR435007C
		8.5	AR435008C
		10	AR435010C
		11.5	AR435011C
		13	AR435013C
		15	AR435015C

Wide Ø5.5

- Cover Screw included.



Fixture Diameter (mm)	Core (mm)	Length (mm)	Ref.C
5.5	3.3	7	FANIH5507C
		8.5	FANIH5508C
		10	FANIH5510C
		11.5	FANIH5511C
		13	FANIH5513C
	3.8	7	AR385507C
		8.5	AR385508C
		10	AR385510C
		11.5	AR385511C
		13	AR385513C
	4.0	7	FANIH5507SC
		8.5	FANIH5508SC
		10	FANIH5510SC
		11.5	FANIH5511SC
		13	FANIH5513SC
		15	FANIH5515SC

Fixture Diameter (mm)	Core (mm)	Length (mm)	Ref.C
5.5	4.3	7	AR435507C
		8.5	AR435508C
		10	AR435510C
		11.5	AR435511C
		13	AR435513C
	4.8	7	AR485507C
		8.5	AR485508C
		10	AR485510C
		11.5	AR485511C
		13	AR485513C
		15	AR485515C

Super Wide Ø6.0

- Cover Screw included.

Fixture Diameter (mm)	Core (mm)	Length (mm)	Ref.C
6.0	4.0	7	AR406007C
		8.5	AR406008C
		10	AR406010C
		11.5	AR406011C
		13	AR406013C
	4.3	7	AR436007C
		8.5	AR436008C
		10	AR436010C
		11.5	AR436011C
		13	AR436013C
	4.8	7	FALHX6007C
		8.5	FALHX6008C
		10	FALHX6010C
		11.5	FALHX6011C
		13	FALHX6013C



Super Wide Ø6.5

- Cover Screw included.

Fixture Diameter (mm)	Core (mm)	Length (mm)	Ref.C
6.5	4.8	7	FALHX6507C
		8.5	FALHX6508C
		10	FALHX6510C
		11.5	FALHX6511C
		13	FALHX6513C



Super Wide Ø7.0

- Cover Screw included.

Fixture Diameter (mm)	Core (mm)	Length (mm)	Ref.C
7.0	4.8	7	FALHX7007C
		8.5	FALHX7008C
		10	FALHX7010C
		11.5	FALHX7011C
		13	FALHX7013C



➔ Fixture Size

Super Wide Ø7.5

- Cover Screw included.

Fixture Diameter (mm)	Core (mm)	Length (mm)	Ref.C
7.5	4.8	7	FALHX7507C
		8.5	FALHX7508C
		10	FALHX7510C
		11.5	FALHX7511C
		13	FALHX7513C

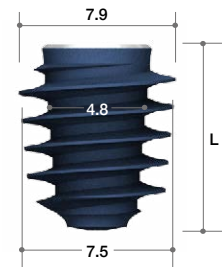

Super Wide Ø8.0

- Cover Screw included.

Fixture Diameter (mm)	Core (mm)	Length (mm)	Ref.C
8.0	4.8	7	FALHX8007C
		8.5	FALHX8008C
		10	FALHX8010C
		11.5	FALHX8011C
		13	FALHX8013C

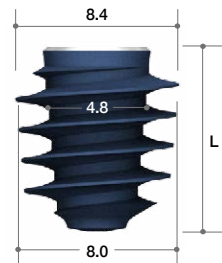

NEW PRODUCT

Special Length

- Cover Screw(cs) included

Fixture Diameter (mm)	Core (mm)	Length (mm)	Ref.C
Ø3.5	3.3	7	AR333505C
Ø4.0	3.3		AR334005C
Ø4.5	3.3		AR334505C
	3.8		AR384505C
Ø5.0	3.3		AR335005C
	3.8		AR385005C
	4.3		AR435005C
Ø5.5	3.3		AR335505C
	3.8		AR385505C
	4.3		AR435505C
	4.8		AR485505C

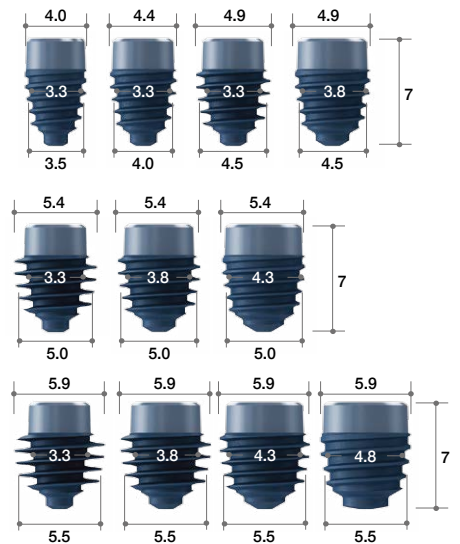

"Special 7mm"
essential for special case



For Irregular Ridge

This 'Special 7mm' fixture can be used for non-uniform bone loss case with limited available vertical dimension.

Ø3.5, Ø4.0, Ø4.5, Ø5.0, Ø5.5



7mm Implant

III. Packaging

- Ampule

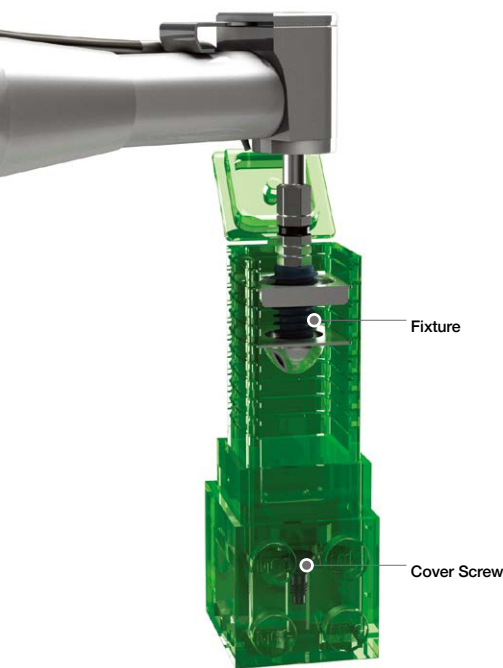

Peel off cover & remove ampule

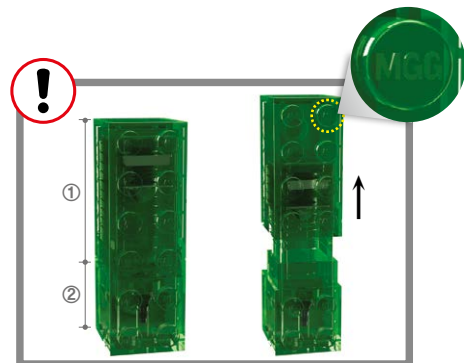

Separate top^① & bottom^②, as shown, to reveal inner ampule with fixture



Flip open top to reveal fixture

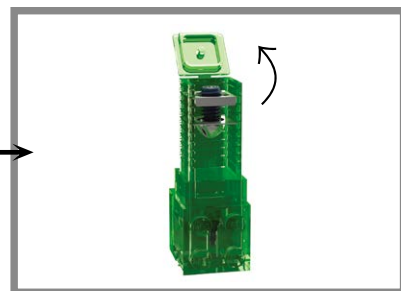

Connect handpiece to fixture



Make sure fixture is fully connected, then remove from ampule



Place fixture according to drilling sequence



Separate fixture ampule from bottom, as shown, to reveal cover screw holder[®]



Use hand driver to pick up cover screw



Tighten cover screw to fixture

MegaGen ampule! Re-usable as building block *after cleaning and sterilization! less plastic waste!

Cover Screw & Healing Abutment

Cover Screw

* Included in the fixture package.

- Use with a Hand Driver(1.2 Hex).
- Used for submerged type surgery.
- Protects the inner structure of a fixture.
- Different heights can be chosen according to the position of fixture below the crest.
- 1.6mm and 2.6mm height of Cover Screw can be purchased separately.
- Recommend torque : by hand (5 - 8Ncm)

Profile Diameter	Height (mm)	Ref.C
Ø3.5	0.8	AANCSF3508
	1.6	AANCSF3516
	2.6	AANCSF3526
Ø5.0	0.5	AANCSF5005
Ø6.0	0.5	AANCSF6005

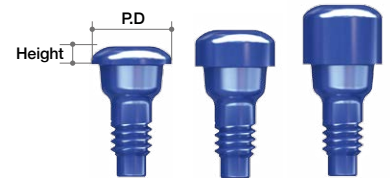

Healing Abutment

- Use with a Hand Driver(1.2 Hex).
- Used for non-submerged type surgery or for two stage surgery.
- Choose appropriate diameter and height of Healing Abutment according to situation.
- Helps to form suitable emergence profile during period of gingival healing.
- Recommend torque : by hand (5 - 8Ncm)



Profile Diameter	Height (mm)	Ref.C
Ø4.0	3	AANHAF0403
	4	AANHAF0404
	5	AANHAF0405
	6	AANHAF0406
	7	AANHAF0407
	8	AANHAF0408
	9	AANHAF0409
Ø5.0	3	AANHAF0503
	4	AANHAF0504
	5	AANHAF0505
	6	AANHAF0506
	7	AANHAF0507
	8	AANHAF0508
	9	AANHAF0509
Ø6.0	3	AANHAF0603
	4	AANHAF0604
	5	AANHAF0605
	6	AANHAF0606
	7	AANHAF0607
	8	AANHAF0608
	9	AANHAF0609

Profile Diameter	Height (mm)	Ref.C
Ø7.0	3	AANHAF0703
	4	AANHAF0704
	5	AANHAF0705
	6	AANHAF0706
	7	AANHAF0707
	8	AANHAF0708
	9	AANHAF0709
Ø8.0	3	AANHAF0803
	4	AANHAF0804
	5	AANHAF0805
	6	AANHAF0806
	7	AANHAF0807
	8	AANHAF0808
	9	AANHAF0809
Ø10.0	3	AANHAF1003
	4	AANHAF1004
	5	AANHAF1005
	6	AANHAF1006
	7	AANHAF1007
	8	AANHAF1008
	9	AANHAF1009

Abutment & Prosthetic Options

I. Fixture Level Prosthesis

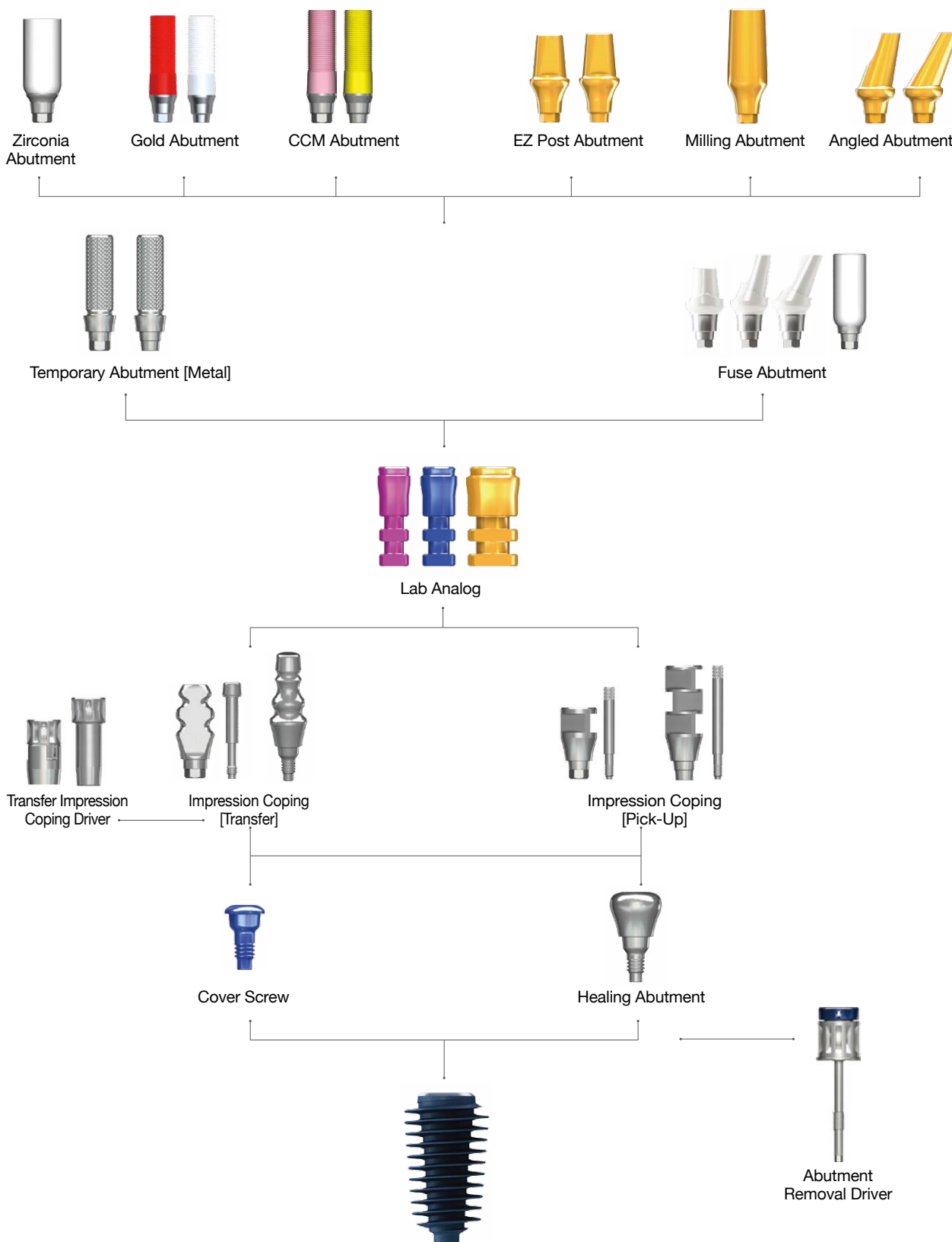

➔ Impression Copings

Impression Coping

(2-piece, Transfer Type)
(For Closed-tray Technique)

- Streamlined shape ; easy to transfer.
- Anti-rotation grooves match with hex structure of fixtures.
- Should be tightened with Impression Driver (Page.352)
- Special impression coping screw which can be used with a 1.2mm hex driver is available on request.

Profile Diameter	Height (mm)	Type	Ref.C
Ø4.0	12	2-Piece	AANITH4012T
	16		AANITH4016T
Ø5.0	12		AANITH5012T
	16		AANITH5016T
Ø4.0	12	2-Piece Hand driver (1.2 Hex)	AANITH4012HT
	16		AANITH4016HT
Ø5.0	12		AANITH5012HT
	16		AANITH5016HT

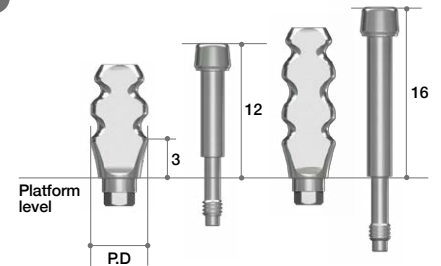

Impression Coping

(1-piece, Transfer Type)
(For Closed-tray Technique)

- Should be tightened with Impression Driver (Page.352)
- Special impression coping screw which can be used with a 1.2mm hex driver is available on request.

Profile Diameter	Height (mm)	Type	Ref.C
Ø4.0	12	1-Piece	AANITN4012
	16		AANITN4016
Ø5.0	12		AANITN5012
	16		AANITN5016
Ø4.0	12	1-Piece Hand driver (1.2 Hex)	AANITN4012H
	16		AANITN4016H
Ø5.0	12		AANITN5012H
	16		AANITN5016H

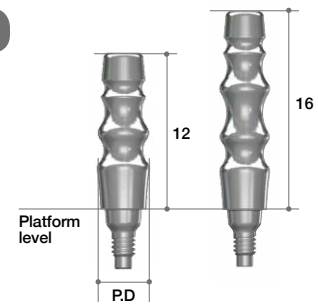

Impression Coping

(2-piece, Pick-up Type)
(For Open-tray Technique)

- Guide Pins : AANGPP0010 (7mm : Short) / AANGPP0015 (12mm : Long) / AANGPP0020 (20mm : Extra-long)

- Square structure ; strong anti - rotation function.
- Designed for easy and accurate pick-up impression.
- Extra-long guide pin can be purchased separately.

Profile Diameter	Height (mm)	Type	Ref.C
Ø4.0	12	2-Piece	AANIPH4012T
	16		AANIPH4016T
	12		AANIPN4012T
	16		AANIPN4016T
Ø5.0	7		AANIPH5007T
	12		AANIPH5012T
	7		AANIPN5007T
	12		AANIPN5012T

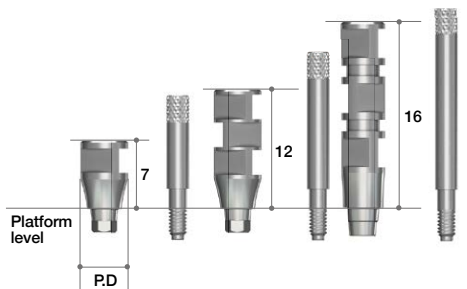

➔ Lab Analog & Temporary Abutments

Lab Analog

Profile Diameter	Color	Ref.C
Ø3.5	Magenta	AANLAF35
Ø4.0 ~ Ø5.5	Blue	AANLAF4055
Ø6.0 ~ Ø8.0	Yellow	AALLAF6080



Temporary Abutment (Titanium)

- Multi Post Screw(AANMSF) included.
- For making provisional restoration.
- Grooved on the post allows strong resin adherence.
- Recommend torque : 25Ncm

Profile Diameter	Cuff Height (mm)	Type	Ref.C
Ø4.0	2	Hex	AANTMH4012T
		Non-Hex	AANTMN4012T

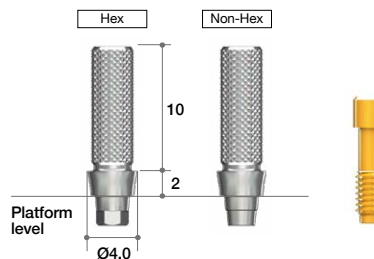

Fuse Abutment

- Straight, 15°, 25° ; Multi Post Screw(AANMSF) included + Fuse Cap included.
- Milling ; Multi Post Screw(AANMSF) included.
- Recommend torque : 25Ncm

Diameter	C.H (mm)	P.H (mm)	Type	Ref.C
Ø5.5	4	5.5	Straight	AFAP5545P
			15°	AFAA5415P
	25°	AFAA5425P		
Ø5.0	1	11	Milling	AANTAH5012T

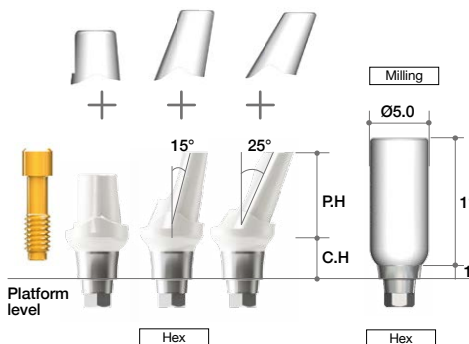

NEW : 4mm cuff height available
 → Adequate for deeply placed implants
 or thick gingival cases

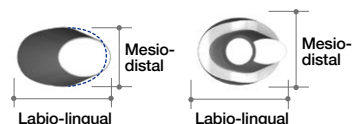

► **Fuse Abutment™**



Why is the 'Fuse Abutment' essential partner for a temporary crown?

Design concept of Fuse Abutment™

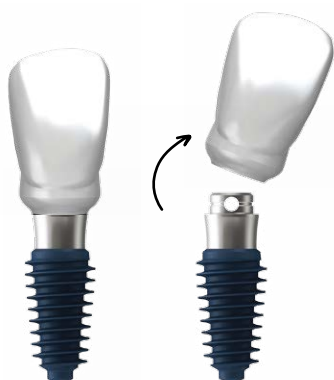

Similar to a customized abutment for excellent esthetics!

Perfect margin fit with a prosthetic cap

Scalloped outline

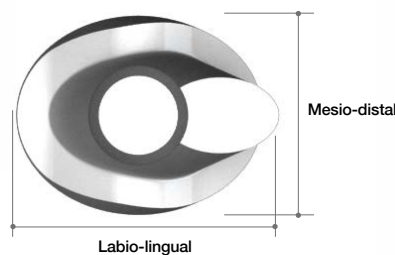

Elliptical Occlusal view like a natural tooth

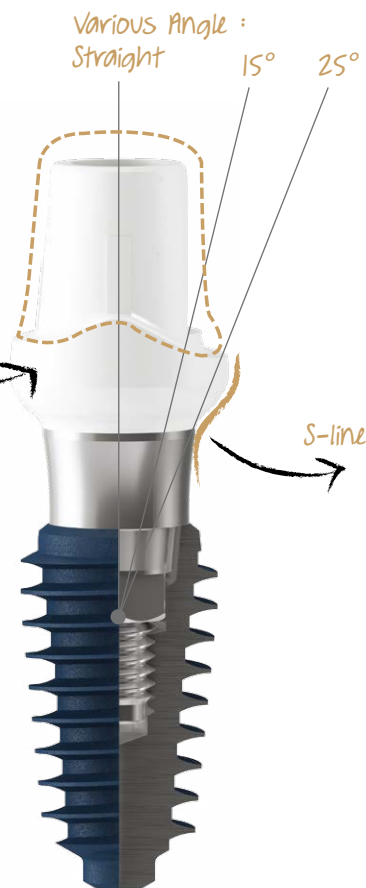

Rationale of Fuse Abutment™

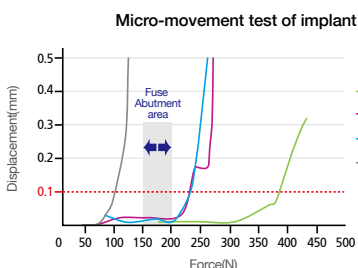

Performed compressive strength test to evaluate the micro movement for bone density using universal testing machine -R&D center in Megagen Implant Co.,Ltd.(2012)-

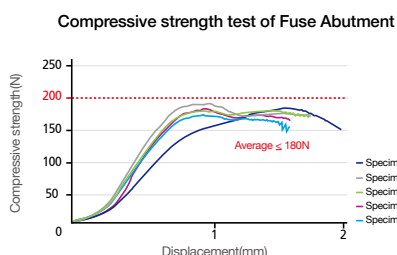

Performed compressive strength test to evaluate the yield strength for Fuse Abutment using universal testing machine -R&D center in Megagen Implant Co.,Ltd.(2012)-

In 1992, Brunski JB. reported that the implant may has a higher possibility of fibrointegration than osseointegration between bone and implant surface when movements of more than 100µm occur on the fixture during osseointegration period. (John B. Brunski, Biomechanical factors affecting the bone-dental implant interface. Clinical Materials, Vol. 10, 153-201) Therefore, the implant was needed to protected not to move when immediate loading is carried out. However, it is not easy to manage loading on the fixture, even when we used a resin temporarily with a titanium cylinder. It was thought that it was partly because of the metal component of temporary cylinder, which can deliver excessive forces to the fixture. This was one of the reasons which made clinicians hesitate the immediate loading procedure. So it was necessary to develop a special temporary cylinder. It should have been broken under the force which could lead fibrointegration or failure of osseointegration to protect the fixture. and it would be preferred if it was easy to make a temporary crown on this particular temporary cylinder. We tried to measure the force causing movement

of 100µm that was placed securely into adequate density of bone without defect. First, AnyRidge implants were placed into the internationally recognized standard bone block with more 40Ncm torque force and an abutment was connected on each implant. Instron equipment was used to measure the force to move a fixture 100µm. The average force was 220N (22.4 kgf). Therefore, if the new temporary abutment can be fracture under this force, it might protect the fixture from movement or failure.



From this experiment, we could developed a special temporary abutment which has lower fracture threshold of less than 200 N (20.4 kgf). It was named as Fuse Abutment. Also it has an anatomic profiles to make temporary prosthetics more esthetic.

➔ Abutment Options (Continued)

EZ Post Abutment

- Multi Post Screw(AANMSF/AANMST) included.

- Use with a Hand Driver (1.2 Hex).
- Esthetic gold coloring.
- Two different post heights. (5.5, 7.0mm)
- Four different profile diameters. (Ø4.0, 5.0, 6.0, 7.0)
- Four different cuff heights. (2.0, 3.0, 4.0, 5.0mm)
- Recommend torque : 35Ncm

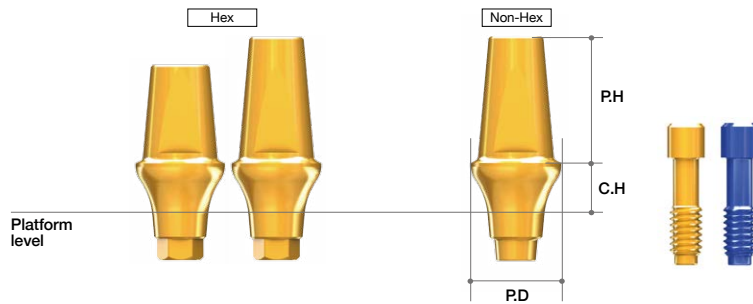

Profile Diameter	Cuff Height(mm)	Post Height(mm)	Type	Ref.C		
Ø4.0	2	5.5	Hex	AANEPH4025L		
	3			AANEPH4035L		
	4			AANEPH4045L		
	5			AANEPH4055L		
	2	7		AANEPH4027L		
	3			AANEPH4037L		
	4			AANEPH4047L		
	5			AANEPH4057L		
	Ø4.0	2		5.5	Non-Hex	AANEPN4025L
		3				AANEPN4035L
4		AANEPN4045L				
5		AANEPN4055L				
2		7	AANEPN4027L			
3			AANEPN4037L			
4			AANEPN4047L			
5			AANEPN4057L			
Ø5.0		2	5.5	Hex		AANEPH5025L
		3				AANEPH5035L
	4	AANEPH5045L				
	5	AANEPH5055L				
	2	7	AANEPH5027L			
	3		AANEPH5037L			
	4		AANEPH5047L			
	5		AANEPH5057L			
	Ø5.0	2	5.5		Non-Hex	AANEPN5025L
		3				AANEPN5035L
4		AANEPN5045L				
5		AANEPN5055L				
2		7	AANEPN5027L			
3			AANEPN5037L			
4			AANEPN5047L			
5			AANEPN5057L			
Ø6.0		2	5.5	Hex		AANEPH6025L
		3				AANEPH6035L
	4	AANEPH6045L				
	5	AANEPH6055L				
	2	7	AANEPH6027L			
	3		AANEPH6037L			
	4		AANEPH6047L			
	5		AANEPH6057L			
	Ø6.0	2	5.5		Non-Hex	AANEPN6025L
		3				AANEPN6035L
4		AANEPN6045L				
5		AANEPN6055L				
2		7	AANEPN6027L			
3			AANEPN6037L			
4			AANEPN6047L			
5			AANEPN6057L			
Ø7.0		2	5.5	Hex		AANEPH7025L
		3				AANEPH7035L
	4	AANEPH7045L				
	5	AANEPH7055L				
	2	7	AANEPH7027L			
	3		AANEPH7037L			
	4		AANEPH7047L			
	5		AANEPH7057L			
	Ø7.0	2	5.5		Non-Hex	AANEPN7025L
		3				AANEPN7035L
4		AANEPN7045L				
5		AANEPN7055L				
2		7	AANEPN7027L			
3			AANEPN7037L			
4			AANEPN7047L			
5			AANEPN7057L			

➔ Abutment Options (Continued)

Gold Abutment

- Multi Post Screw(AANMSF/AANMST) included.

- Useful to make a customized abutment in difficult situations.
- Precious and non-precious alloys.
- Melting point of gold alloy : 1063°C
- Threaded sleeves for convenient Resin / Wax-up.
- Recommend torque : 30Ncm

Profile Diameter	Cuff Height(mm)	Post Height(mm)	Type	Ref.C
Ø4.0	1	11	Hex	AANGAH4012L
			Non-Hex	AANGAN4012L

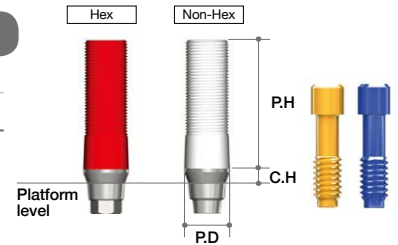

Zirconia Abutment

- Multi Post Screw(AANMSF/AANMST) included.

- For esthetic use.
- Natural white color with pre-sintered zirconia sleeve.
- Presinpered Zirconia Abutment.
- Preparable at the chair side with a diamond bur.
- Recommend torque : 35Ncm

Profile Diameter	Cuff Height(mm)	Post Height(mm)	Type	Ref.C
Ø4.0	1	11	Hex	AANZAH4012L
Ø5.0				AANZAH5012L

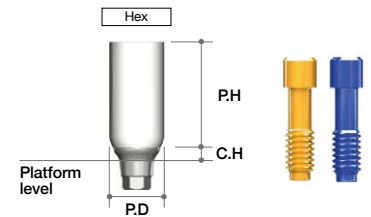

Milling Abutment

- Multi Post Screw(AANMSF/AANMST) included.

- Long post enables easier customization from milling.
- Recommend torque : 35Ncm

Profile Diameter	Cuff Height(mm)	Post Height(mm)	Ref.C
Ø4.0	2	9	AANMAH4029L
	3		AANMAH4039L
	4		AANMAH4049L
	5		AANMAH4059L
Ø5.0	2	9	AANMAH5029L
	3		AANMAH5039L
	4		AANMAH5049L
	5		AANMAH5059L
Ø6.0	2	9	AANMAH6029L
	3		AANMAH6039L
	4		AANMAH6049L
	5		AANMAH6059L
Ø7.0	2	9	AANMAH7029L
	3		AANMAH7039L
	4		AANMAH7049L
	5		AANMAH7059L

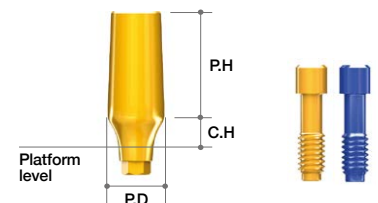

Milling Abutment Type II (BOPT Abutment)

- AnyRidge Internal : Multi Post Screw (AANMSF/ AANMST) included.

- Long post enables easier customization from milling.
- Recommend torque : 35Ncm

Profile Diameter	Cuff Height(mm)	Post Height(mm)	Type	Ref.C
Ø4.0	1	19	Hex	ARBOT4019HL
			Non-Hex	ARBOT4019NL

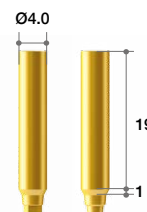

B.O.P.T (Biologically Oriented Preparation Technique)

MegaGen family thanks to MD. Oscar Alonso Gonzalez & Dr. Fabio Galli for the suggestion of B.O.P.T abutment

- To obtain thick, healthy and stable soft tissue around tooth

Characteristics of B.O.P.T

1. Morphology without a finish line.
2. Conical Shape.
3. Prosthetic Platform Switching

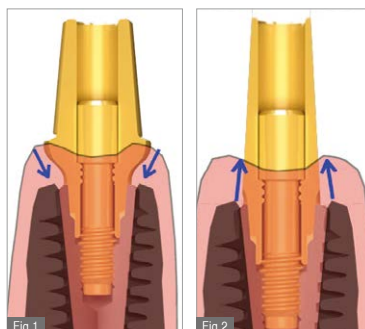
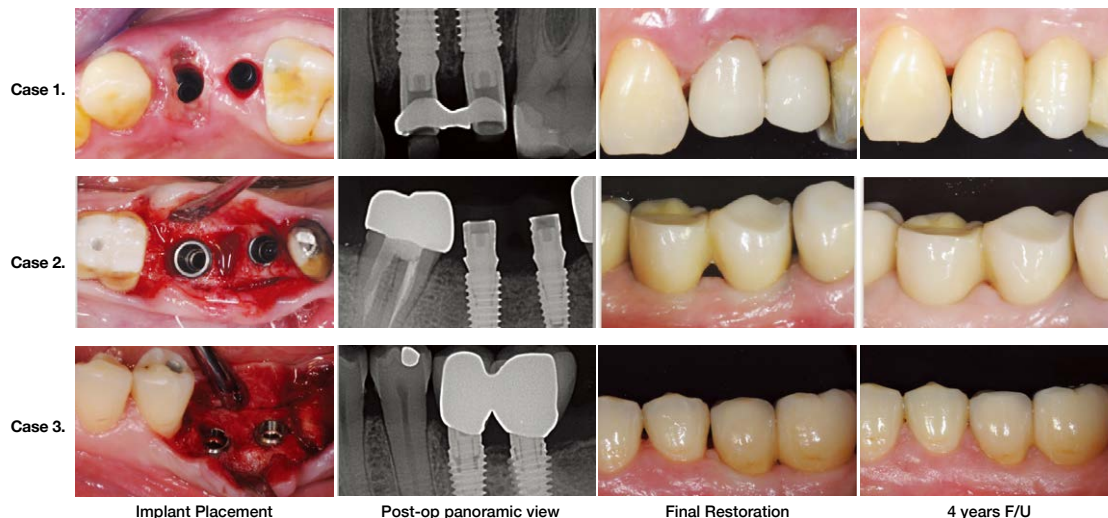

Fig 1. With its divergent profile, it tends to stabilize the circular fibers of the connective tissue towards apical.

Fig 2. In the same way as with the teeth, this abutment facilitates the stabilization of the circular fibers of the connective tissue at a more coronal level compared to a standard rehabilitation.

B.O.P.T Clinical Case

- Courtesy of Dr. Fabio Galli



➔ Abutment Options (Continued)

Angled Abutment

- Multi Post Screw(AANMSF/AANMST) included.

- Two different angulations. (15°, 25°)
- Four different profile diameters. (Ø4.0, 5.0, 6.0, 7.0)
- Four different cuff heights. (2, 3, 4, 5mm)
- Can cover 12 different directions. [six to the surface(Hex), six to the edge of hex(Hex-E)]
- Esthetic gold coloring.
- Minimized screw head length needs minimum height to prevent milling problems.
- Recommend torque : 35Ncm

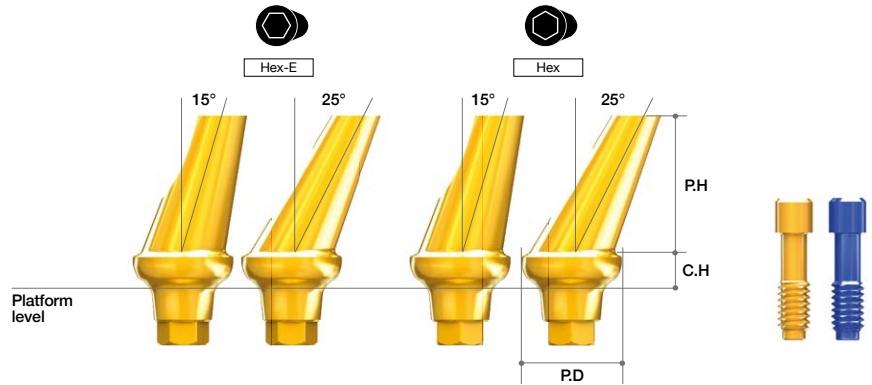

Profile Diameter	Cuff Height(mm)	Post Height(mm)	Type	Angle	Ref.C
Ø4.0	2	7	Hex	15°	AANAAH4215L
	3				AANAAH4315L
	4				AANAAH4415L
	5				AANAAH4515L
	2				AANAAE4215L
	3				AANAAE4315L
	4				AANAAE4415L
	5				AANAAE4515L
	2		Hex	25°	AANAAH4225L
	3				AANAAH4325L
	4				AANAAH4425L
	5				AANAAH4525L
	2				AANAAE4225L
	3				AANAAE4325L
	4				AANAAE4425L
	5				AANAAE4525L
Ø5.0	2	7	Hex	15°	AANAAH5215L
	3				AANAAH5315L
	4				AANAAH5415L
	5				AANAAH5515L
	2				AANAAE5215L
	3				AANAAE5315L
	4				AANAAE5415L
	5				AANAAE5515L
	2		Hex	25°	AANAAH5225L
	3				AANAAH5325L
	4				AANAAH5425L
	5				AANAAH5525L
	2				AANAAE5225L
	3				AANAAE5325L
	4				AANAAE5425L
	5				AANAAE5525L

Profile Diameter	Cuff Height(mm)	Post Height(mm)	Type	Angle	Ref.C
Ø6.0	2	7	Hex	15°	AANAAH6215L
	3				AANAAH6315L
	4				AANAAH6415L
	5				AANAAH6515L
	2				AANAAE6215L
	3				AANAAE6315L
	4				AANAAE6415L
	5				AANAAE6515L
	2		Hex	25°	AANAAH6225L
	3				AANAAH6325L
	4				AANAAH6425L
	5				AANAAH6525L
	2				AANAAE6225L
	3				AANAAE6325L
	4				AANAAE6425L
	5				AANAAE6525L
Ø7.0	2	7	Hex	15°	AANAAH7215L
	3				AANAAH7315L
	4				AANAAH7415L
	5				AANAAH7515L
	2				AANAAE7215L
	3				AANAAE7315L
	4				AANAAE7415L
	5				AANAAE7515L
	2		Hex	25°	AANAAH7225L
	3				AANAAH7325L
	4				AANAAH7425L
	5				AANAAH7525L
	2				AANAAE7225L
	3				AANAAE7325L
	4				AANAAE7425L
	5				AANAAE7525L

CCM Abutment

- Multi Post Screw(AANMSF/AANMST) included.

- Useful to make a customized abutment in difficult situations.
- Can be casted with non-precious alloys (Ni-Cr, Cr-Co alloys).
- Non-precious melting temperature : Depend on Manufacturer
- Threaded sleeves for convenient Resin / Wax-up.
- Melting temperature of CCM : 1300~1400°C
- Recommend torque : 35Ncm

Profile Diameter	Cuff Height(mm)	Post Height(mm)	Type	Ref.C
Ø4.0	1	11	Hex	AANCAH4012L
			Non-Hex	AANCAN4012L

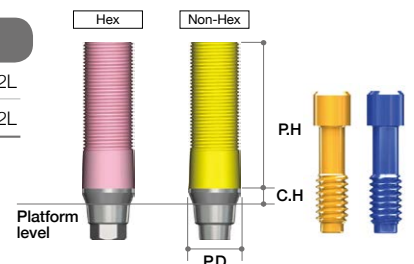

I. Fixture Level Prosthesis

1. Fixture Level Prosthesis_Extra EZ Post

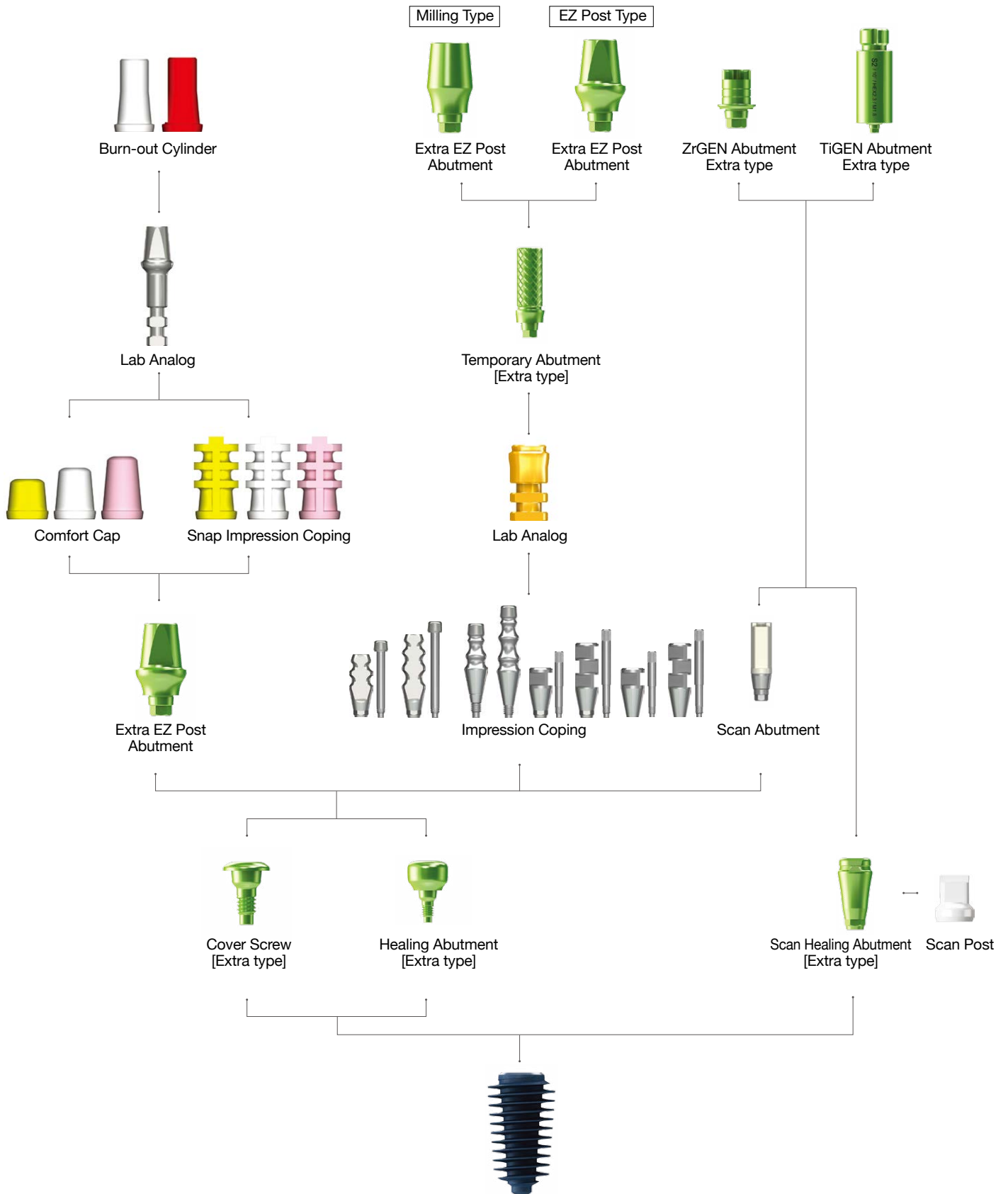

S2 Option for successful 'second molar implant'

AnyRidge challenges to the HIGH SURVIVAL RATE even at the second molar

You may already know that

'second molar Implant' has much less success rate than others

1) Simple Literature Reviews:

<General Implant success rate>
99.7% - 10-year survival rate at implant
 - *van Velzen FJ et al. (2014)*
95.6%, 94.4%, 96.1%, 100%, 90.6%, 95.7% - CSR of 759 implants in single-tooth prostheses, cantilever fixed, partial prostheses, fixed partial prostheses, fixed complete prostheses, implant/tooth-connected prostheses, and overdentures - *Romeo E et al. (2004)*

<Second molar Implant Success rate>
"89.0%" - CSR of 392 implants in the posterior mandible for 6 yrs - *Parein et al. (1997)*
"91.1%" - 2nd Molar survival Rate for 2 yrs - *YK kim et al. (2010)*
"82.9%", "91.5%" - Prospective study on 282 implants placed in the Mx and Mn molar position (6 years cumulative study) *Becker et al. (1999)*
8.16% failure in the Mx, **4.93%** in the Mn - *Moy et al (2005)*

Problem

2) Why less success rate at the Second Molar?

Handicaps of the Second Molar Implant ;

- 1. Less quality & quantity of alveolar bone**
 - Maxillary 2nd Molar site usually show less quality (Type IV or worse) and/or limited height due to Sinus pneumatization.
 - Mandible 2nd Molar site usually show less blood supply which is important for adequate alveolar bone metabolism. And limited height of bone due to the inferior mandibular nerve.
- 2. Strong Occlusal force**
 Due to special joint system at TMJ, the Second Molar usually endure strong occlusal force during mastication.
- 3. Hygiene Problem**
 Due to remote position, it's very difficult to maintain hygiene at the second Molar, especially at the distal area, So easy to get peri-implantitis than others.

Solution

3) How to overcome less success rate?

Possible solution

- We need an implant system which can provide **excellent initial stability**¹ even at the loose bone and limited height of bone.
- We need an implant system which can provide **enough surface area**² for osseointegration, even at the limited height of bone.
- We need to provide **enough space for angiogenesis and blood supply**³ for more active bone remodeling.

We need **stronger implant fixture and abutment connection**⁴ to withstand occlusal forces and lateral movement.

We need to choose **adequate material**⁵ for abutment and crown, which retains much less plaque, even with less accessibility and hygiene skills.

4) MegaGen's suggestion for the second molar implant

"S2 Option" strongly recommended by KOLs of MegaGen.

- ① Excellent initial stability at loose bone
- ② Enough surface area for osseointegration

Already well-know advantages of AnyRidge Implant System.



"S2 Option"
 1. Less quality & quantity of alveolar bone

thread	length (mm)	S.S. surface (mm ²)	S.S. surface (mm ²)
1 st	1.0	15,739	15,739
2 nd	1.8	41,299	45,013
3 rd	2.6	72,262	84,771
4 th	3.4	102,739	123,85
5 th	4.2	132,213	161,497
6 th	5.0	160,362	197,971
7 th	5.8	187,153	232,633
8 th	6.6	212,613	265,709
9 th	7.2	230,851	289,492
10 th	8.0	253,937	319,185
Apex	8.8	265,953	331,263

EZ plus surface area (mm²)

04.0 X 7	130,614
04.0 X 8.5	135,901
04.0 X 10	164,73
05.0 X 7	170,038
05.0 X 8.5	182,968
05.0 X 10	214,568

[Surface area comparison between AnyRidge and EZ plus]

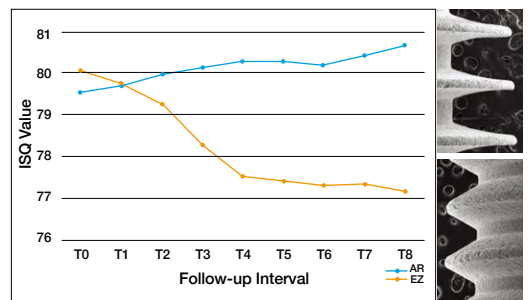

[ISQ value comparison between AnyRidge and EZ plus]

You may already know that

'second molar Implant' has much less success rate than others

2nd molar immediate placement case



Fig.1 After extraction

Fig.2 Immediate placement

Fig.3 Final restoration

Fig.4 7yr F/U

- 4.8 core diameter and deep thread AnyRidge implant will create very strong and satisfactory initial stability at the large extraction socket of second molar.

- Courtesy of Dr. Kwang Bum Park

③ Enough space for angiogenesis and blood supply through the inter-thread space

- Knife thread design of AnyRidge implant creates the maximum space for blood supply

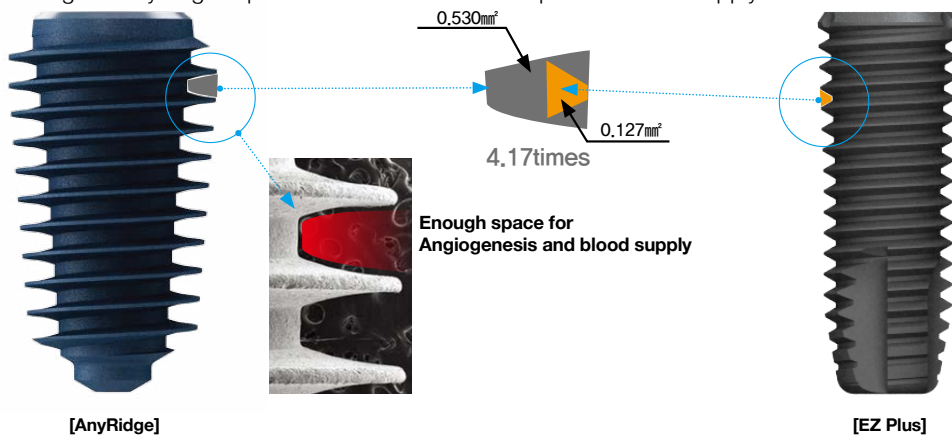

[AnyRidge]

[EZ Plus]

④ Stronger fixture and abutment connection

Fixture Selection

- For the strength of successful second molar implant, our KOLs strongly recommend to use 'Core Diameter' wider than 3.8mm.
- If there is enough width of bone, 4.3mm or 4.8mm core AnyRidge fixture would be better.
- At the large extraction socket of second molar, we recommend 4.8mm core and deep thread AnyRidge implant.

Core Diameter	Fixture Diameter									
	Ø3.5	Ø4.0	Ø4.5	Ø5.0	Ø5.5	Ø6.0	Ø6.5	Ø7.0	Ø7.5	Ø8.0
Ø2.8										
Thread depth	0.3									
Ø3.3										
Thread depth		0.35	0.6	0.85	1.1					
Ø3.8										
Thread depth			0.35	0.6	0.85					S2 Option
Ø4.0										
Thread depth				0.45	0.7	0.95				
Ø4.3										
Thread depth				0.35	0.6	0.85				
Ø4.8										
Thread depth					0.35	0.6	0.85	1.1	1.35	1.6

Abutment Selection

- 5° AnyRidge connection is really strong and shows almost no biological width.
- Double offset (Implant switching and Abutment switching) is very helpful to improve soft tissue esthetics and health.
- However, at the second molar implant, the strength against lateral occlusal force is more critical than esthetics.
- So our KOLs strongly recommend to use 'Extra EZ Connection' for abutment.

[Normal connection]

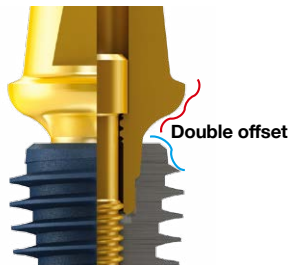

★ [S2 Option : Double connection]

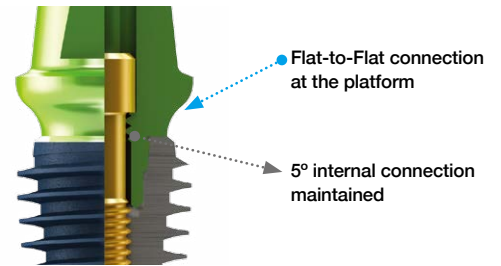

Compressive strength is improved by **67%**

This 'Double connection' has double advantages.

1. Strong resistance to lateral occlusal forces
2. No sinking of prosthetics
 - Most of internal connection shows 30~50 μ m of sinking following delivery of crown
 - S2 Option will not show sinking phenomenon, while maintaining the 5° internal connection

⑤ Adequate material for hygiene

Our KOLs recommend zirconia customized abutment and/or zirconia monolithic crown for the second molar implant.

Bioinert Bioaffinity

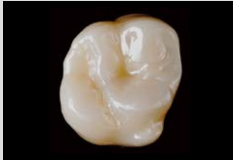

ZrGEN(Extra EZ)

ZrGEN is the brand name of MegaGen Titanium Base. The strength of ZrGEN frees you from the chipping to conventional PFM prosthesis. Monolithic zirconia crowns have no metal substructure,

enhancing better survival rate !

Bacterial Adhesion on Commercially Pure Titanium and Zirconium Oxide Disks: An In Vivo Human Study

Antonio Scarano, Maurizio Plattelli, Sergio Caputi, Gian Antonio Favero, and Adriano Plattelli JP 2004

The mucosal barrier at implant abutments of different materials

Maria Welander, Ingemar Abrahamsson, Tord Berglundh COIR19, 2008; 635-641



Titanium. A homogeneous layer of cocci or filamentous bacteria covers the titanium surface

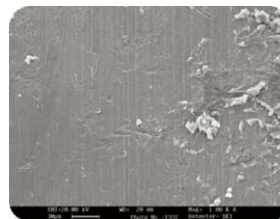

Zirconium oxide. A small number of bacteria cover the zirconium oxide surface.



(from left: Ti, ZrO₂, Ti, Au/Pt-alloy) in place 1 month after implant placement

- However, the Zirconia customized abutment has limitations on strength which leads fracture of zirconia and/or cement-break between ti-insert and Zirconia abutment.
- So MegaGen developed new 'Ti-insert' for the stronger customized abutment!

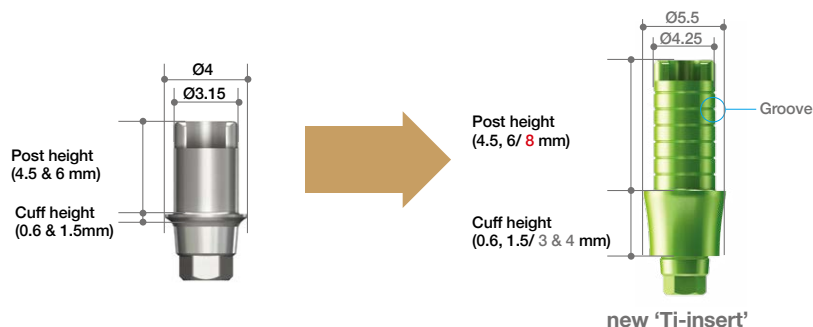

S2 Option with AnyRidge Clinical Case

➔ Clinical Case 1

- Courtesy of Dr. Seung Yeup Lee

S2 Option Line-up with AnyRidge implant can be the best solution in posterior zone

Fig 1. Initial Photo

Fig 2. Harvest Autogenous Bone

Fig 3. Implant placement

Fig 4. Provisionalization

Fig 5, 6. Before / After Surgery

Fig 7. Final Delivery

Fig 8. 6 yrs F/U

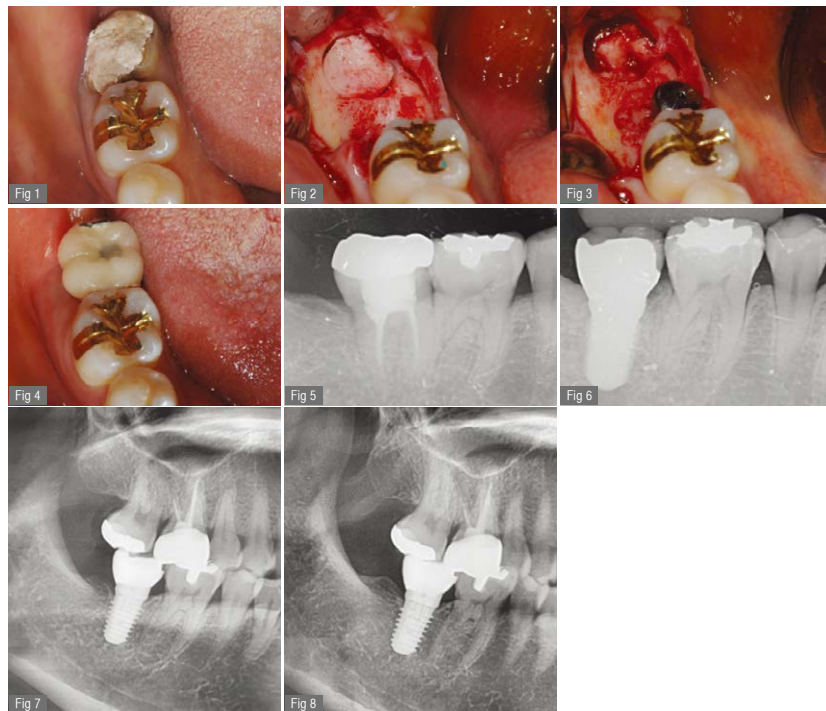

➔ Clinical Case 2

- Courtesy of Dr. Seung Yeup Lee

S2 Option Line-up with AnyRidge implant can be the best solution in posterior zone

Fig 1. Intra Oral before surgery

Fig 2. Panorama view

Fig 3. After Implant Placement

Fig 4. Connect Extra EZ-Post

Fig 5. Zirconia Customized Abutment using ZrGen

Fig 6, 7. Connect PMMA

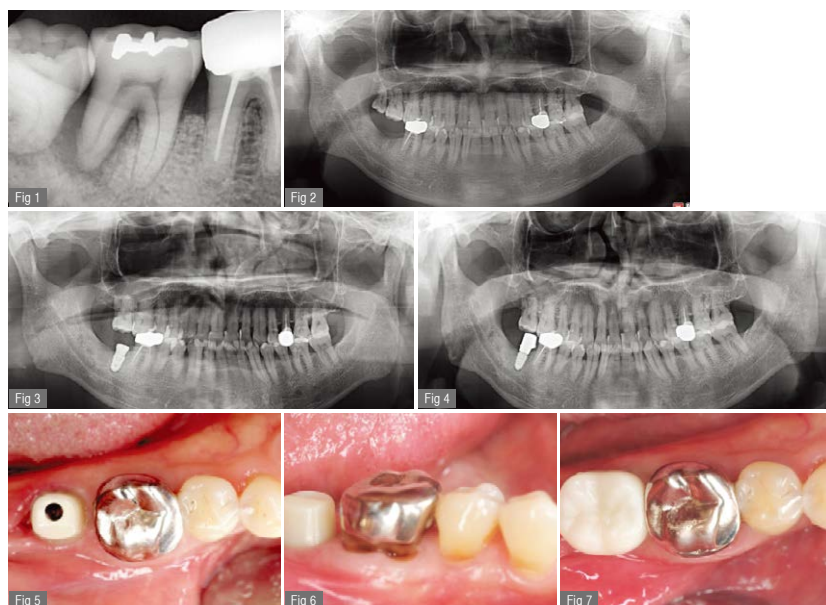

➔ Extra EZ Post Abutment

Extra EZ Post Abutment

- Multi Post Screw(AANMSF/AANMST) included.
- Useful when fixture is exposed over the gum line.
- Recommend torque : 35Ncm

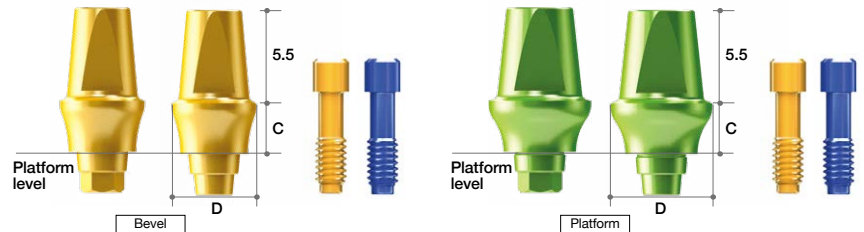

EZ Post Type

Core Diameter	Profile Diameter	Cuff	Type	Ref.C
Ø3.3	Ø5.0	2	Hex	ARNEEH5025L
				ARNEEH5035L
				ARNEEH5045L
				ARNEEH5055L
			Non-Hex	ARNEEN5025L
				ARNEEN5035L
				ARNEEN5045L
				ARNEEN5055L
	Ø6.0	2	Hex	ARNEEH6025L
				ARNEEH6035L
				ARNEEH6045L
				ARNEEH6055L
			Non-Hex	ARNEEN6025L
				ARNEEN6035L
				ARNEEN6045L
				ARNEEN6055L

Core Diameter	Profile Diameter	Cuff	Type	Ref.C
Ø4.0	Ø6.0	2	Hex	ARREEH6025L
				ARREEH6035L
				ARREEH6045L
				ARREEH6055L
			Non-Hex	ARREEN6025L
				ARREEN6035L
				ARREEN6045L
				ARREEN6055L
	Ø7.0	2	Hex	ARREEH7025L
				ARREEH7035L
				ARREEH7045L
				ARREEH7055L
			Non-Hex	ARREEN7025L
				ARREEN7035L
				ARREEN7045L
				ARREEN7055L

Milling Type

Core Diameter	Profile Diameter	Cuff Height	Post Height	Type	Ref.C
Ø3.3	Ø5.5	3	5.5	Bevel	AANEH3335L
Ø4.0	Ø5.5			Platform	AANEH4035L
Ø4.8	Ø6.5			Platform	AANEH4835L

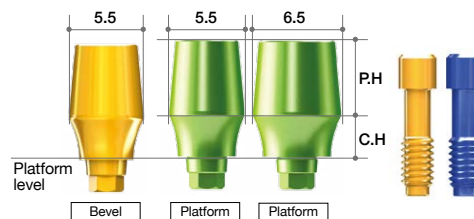

- AANEH3335 used for fixture (Ø4.0~5.5)
- AANEH4035 used for fixture (Ø5.0, Ø5.5_Core ø4)
 - AANEH4035 is for the Core Diameter ø4.0mm (Fixture Diameter Ø5.0~5.5mm). It also can be used for Fixture Diameter Ø6.0~8.0mm for platform switching.
- AANEH4835 used for fixture (Ø6.0~8.0)
- Recommend torque : 35Ncm

➔ Components for Extra EZ Post Abutment

Cover Screw

(Extra Type)

- Included in the fixture package.

- Use with a Hand Driver(1.2 Hex).
- Used for submerged type surgery.
- Protects the inner structure of a fixture.
- Different heights can be chosen according to the position of fixture below the crest.
- 1.6mm and 2.6mm height of Cover Screw can be purchased separately.
- Recommend torque : by hand (5 - 8Ncm)

Core Diameter	Profile Diameter	Type	Ref.C
Ø3.3	Ø4.0	Bevel	AANCSF4008
Ø4.0	Ø4.25	Platform	AANCSF4208

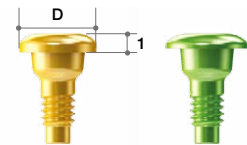

Extra Healing Abutment

- Use with a Hand Driver(1.2 Hex).
- Used for non-submerged type surgery or for two stage surgery.
- Choose appropriate diameter and height of Healing Abutment according to situation.
- Helps to form suitable emergence profile during period of gingival healing.
- Recommend torque : by hand (5 - 8Ncm)

Core Diameter	Profile Diameter	Height (mm)	Type	Ref.C		
Ø3.3	Ø5.0	3	Bevel	ARNEHA503		
		4		ARNEHA504		
		5		ARNEHA505		
		6		ARNEHA506		
		7		ARNEHA507		
		Ø6.0		3	ARNEHA603	
				4	ARNEHA604	
	5		ARNEHA605			
	6		ARNEHA606			
	7		ARNEHA607			
	Ø4.0		Ø4.2	3	Platform	ARREHA403
				4		ARREHA404
		5		ARREHA405		
		6		ARREHA406		
7		ARREHA407				
Ø6.0		3		ARREHA603		
		4		ARREHA604		
		5	ARREHA605			
		6	ARREHA606			
		7	ARREHA607			
		Ø7.0	3	ARREHA703		
			4	ARREHA704		
5			ARREHA705			
6			ARREHA706			
7	ARREHA707					
Ø4.8	Ø6.5		4		AANHAF484	

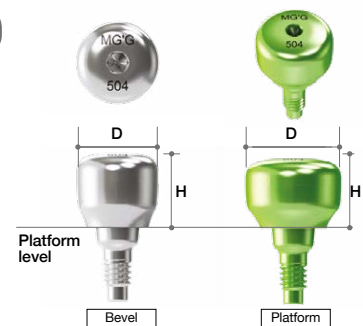

Lab Analog

Profile Diameter	Color	Ref.C
Ø4.0 ~ Ø5.5	Blue	AANLAF4055
Ø6.0 ~ Ø8.0	Yellow	AALLAF6080

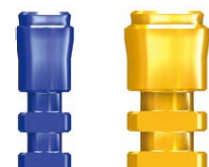

Impression Coping

(2-piece, Transfer Type)
(For Closed-tray Technique)

- Streamlined shape ; easy to transfer.
- Anti-rotation grooves match with hex structure of fixtures.
- Should be tightened with Impression Driver (Page.352)
- Special impression coping screw which can be used with a 1.2mm hex driver is available on request.

Profile Diameter	Height (mm)	Type	Ref.C
Ø4.0	12	2-Piece	AANITH4012T
	16		AANITH4016T
Ø5.0	12		AANITH5012T
	16		AANITH5016T
Ø4.0	12	2-Piece Hand driver (1.2 Hex)	AANITH4012HT
	16		AANITH4016HT
Ø5.0	12		AANITH5012HT
	16		AANITH5016HT

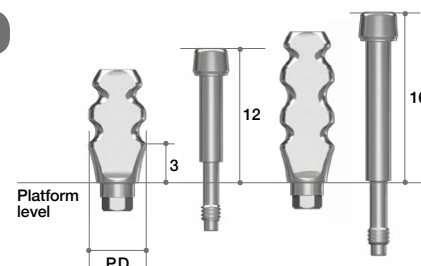

Impression Coping

(1-piece, Transfer Type)
(For Closed-tray Technique)

- Should be tightened with Impression Driver (Page.352)
- Special impression coping screw which can be used with a 1.2mm hex driver is available on request.

Profile Diameter	Height (mm)	Type	Ref.C
Ø4.0	12	1-Piece	AANITN4012
	16		AANITN4016
Ø5.0	12		AANITN5012
	16		AANITN5016
Ø4.0	12	1-Piece Hand driver (1.2 Hex)	AANITN4012H
	16		AANITN4016H
Ø5.0	12		AANITN5012H
	16		AANITN5016H

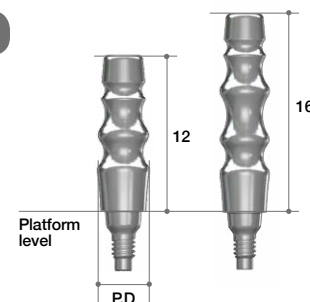

Impression Coping

(2-piece, Pick-up Type)
(For Open-tray Technique)

- Guide Pins : AANGPP0010 (7mm : Short) / AANGPP0015 (12mm : Long) / AANGPP0020 (20mm : Extra-long)

- Square structure ; strong antirotation function.
- Designed for easy and accurate pick-up impression.
- Extra-long guide pin can be purchased separately.

Profile Diameter	Height (mm)	Type	Ref.C
Ø4.0	12	2-Piece	AANIPH4012T
	16		AANIPH4016T
	12		AANIPN4012T
	16		AANIPN4016T
Ø5.0	7		AANIPH5007T
	12		AANIPH5012T
	7		AANIPN5007T
	12		AANIPN5012T

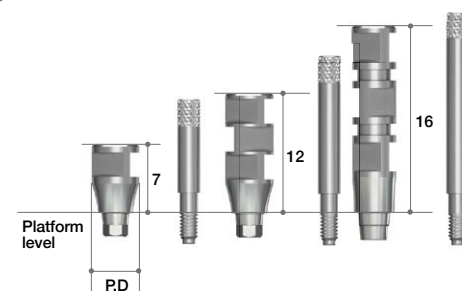

Temporary Abutment

(Titanium Extra Type)

- fixture package included.

- Use with a Hand Driver(1.2 Hex).
- Used for submerged type surgery.
- Protects the inner structure of a fixture.
- Different heights can be chosen according to the position of fixture below the crest.
- 1.6mm and 2.6mm height of Cover Screw can be purchased separately.
- Recommend torque : by hand (5 - 8Ncm)

Core Diameter	Profile Diameter	Type Mount	Connection	Ref.C
Ø3.3	Ø4.5	Bevel	Hex	ARNTAH4510T
			Non-Hex	ARNTAN4510T
Ø4.0	Ø4.75	Platform	Hex	ARRTAH4710T
			Non-Hex	ARRRTAN4710T

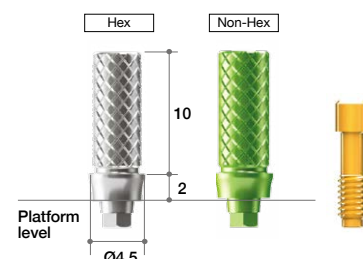

II. Abutment Level Prosthesis

1. Solid Abutment & Components

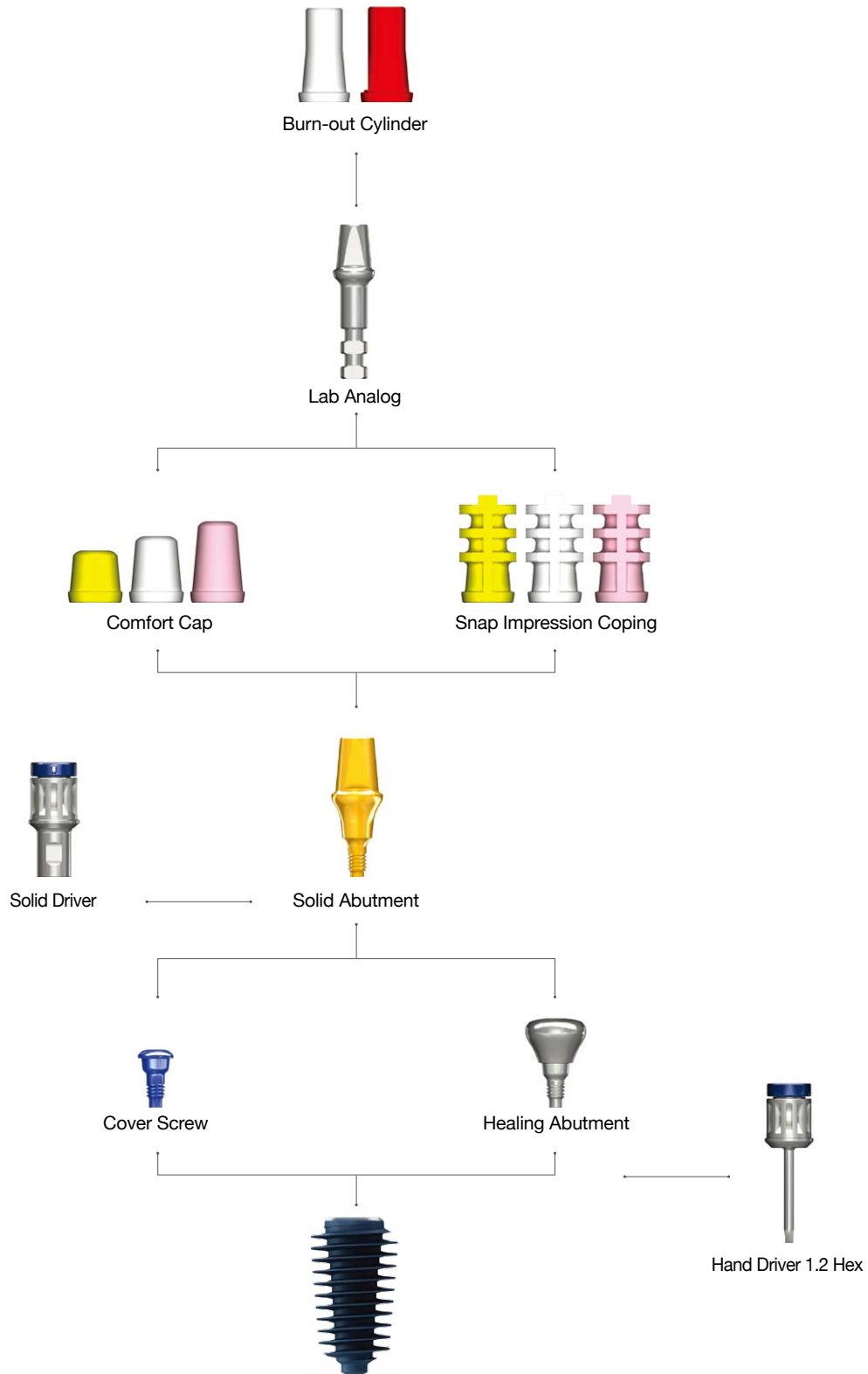

➔ Solid Abutment Option

Solid Abutment

- Used in cement retained restoration only.
- Solid Abutment should be placed into patient's mouth before taking impression.
- Onebody (screw + abutment)
- Should be tightened with a Solid Driver and a Torque Wrench : 35Ncm
- Four different profile diameters. (Ø4.0/5.0/6.0/7.0)
 - Should be tightened with special Solid Driver.
 - Wider profile has bigger post angulation. (4mm - 8°, 5mm - 10°, 6mm - 12°, 7mm - 14°)
- Four different cuff heights. (2/3/4/5mm)
- Three different post heights. (4/5.5/7mm)
- Recommend torque : 35Ncm

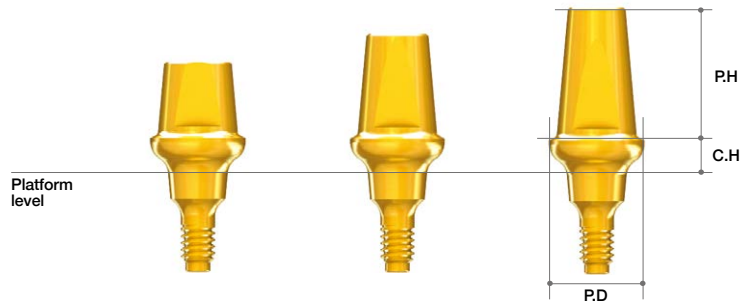

Profile Diameter	Cuff Height(mm)	Post Height(mm)	Ref.C
Ø4.0	2	4	AANSAL4024
	3		AANSAL4034
	4		AANSAL4044
	5		AANSAL4054
	2	5.5	AANSAL4025
	3		AANSAL4035
	4		AANSAL4045
	5		AANSAL4055
	2	7	AANSAL4027
	3		AANSAL4037
	4		AANSAL4047
	5		AANSAL4057
Ø5.0	2	4	AANSAL5024
	3		AANSAL5034
	4		AANSAL5044
	5		AANSAL5054
	2	5.5	AANSAL5025
	3		AANSAL5035
	4		AANSAL5045
	5		AANSAL5055
	2	7	AANSAL5027
	3		AANSAL5037
	4		AANSAL5047
	5		AANSAL5057

Profile Diameter	Cuff Height(mm)	Post Height(mm)	Ref.C
Ø6.0	2	4	AANSAL6024
	3		AANSAL6034
	4		AANSAL6044
	5		AANSAL6054
	2	5.5	AANSAL6025
	3		AANSAL6035
	4		AANSAL6045
	5		AANSAL6055
	2	7	AANSAL6027
	3		AANSAL6037
	4		AANSAL6047
	5		AANSAL6057
Ø7.0	2	4	AANSAL7024
	3		AANSAL7034
	4		AANSAL7044
	5		AANSAL7054
	2	5.5	AANSAL7025
	3		AANSAL7035
	4		AANSAL7045
	5		AANSAL7055
	2	7	AANSAL7027
	3		AANSAL7037
	4		AANSAL7047
	5		AANSAL7057

➔ Components for Solid Abutment (Continued)

Snap Impression Coping

- For impression on Solid Abutments.
- 3 colors for different post heights.
- 4 different diameters for profile diameters. (Ø4, 5, 6, 7)
- Do not use when abutment is trimmed.

Profile Diameter	Ref.C
Ø4.0	AANSIF440
	AANSIF455
	AANSIF470
Ø5.0	AANSIF540
	AANSIF555
	AANSIF570
Ø6.0	AANSIF640
	AANSIF655
	AANSIF670
Ø7.0	AANSIF740
	AANSIF755
	AANSIF770

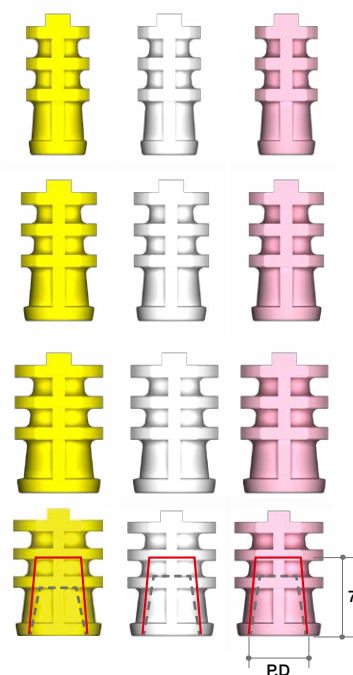

Comfort Cap

- Protects the Solid Abutment and minimizes irritation to tongue and oral mucosa.
- Can be applied under temporary prosthetics.
- Color coded according to post heights.

Profile Diameter	Post Height(mm)	Ref.C
Ø4.0	4	AANCCF440
	5.5	AANCCF455
	7	AANCCF470
Ø5.0	4	AANCCF540
	5.5	AANCCF555
	7	AANCCF570
Ø6.0	4	AANCCF640
	5.5	AANCCF655
	7	AANCCF670
Ø7.0	4	AANCCF740
	5.5	AANCCF755
	7	AANCCF770

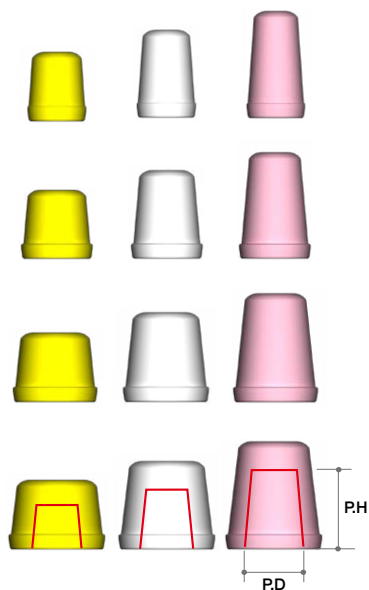

➔ Components for Solid Abutment

Lab Analog

- Directly connected to the Snap Impression Coping in the impression to make a stone model.

Profile Diameter	Height(mm)	Ref.C
Ø4.0	4	AANSLF440
	5.5	AANSLF455
	7	AANSLF470
Ø5.0	4	AANSLF540
	5.5	AANSLF555
	7	AANSLF570
Ø6.0	4	AANSLF640
	5.5	AANSLF655
	7	AANSLF670
Ø7.0	4	AANSLF740
	5.5	AANSLF755
	7	AANSLF770

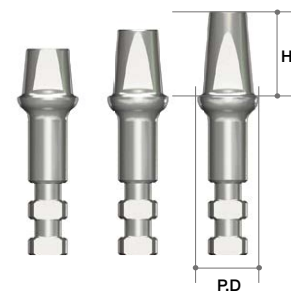

Burn-out Cylinder

- Fits with a Lab Analog(solid level).
- Easy to wax-up and accurate casting.
- White Cylinder for multiple unit.
- Red Cylinder for single crown.

Profile Diameter	Type	Ref.C
Ø4.0	Multiple	AANBCB470
Ø5.0		AANBCB570
Ø6.0		AANBCB670
Ø7.0		AANBCB770
Ø4.0	Single	AANBCS470
Ø5.0		AANBCS570
Ø6.0		AANBCS670
Ø7.0		AANBCS770

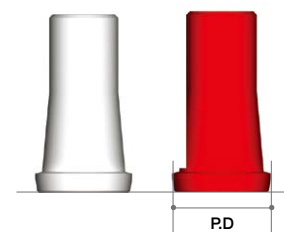

II. Abutment Level Prosthesis

2. Octa Abutment & Components

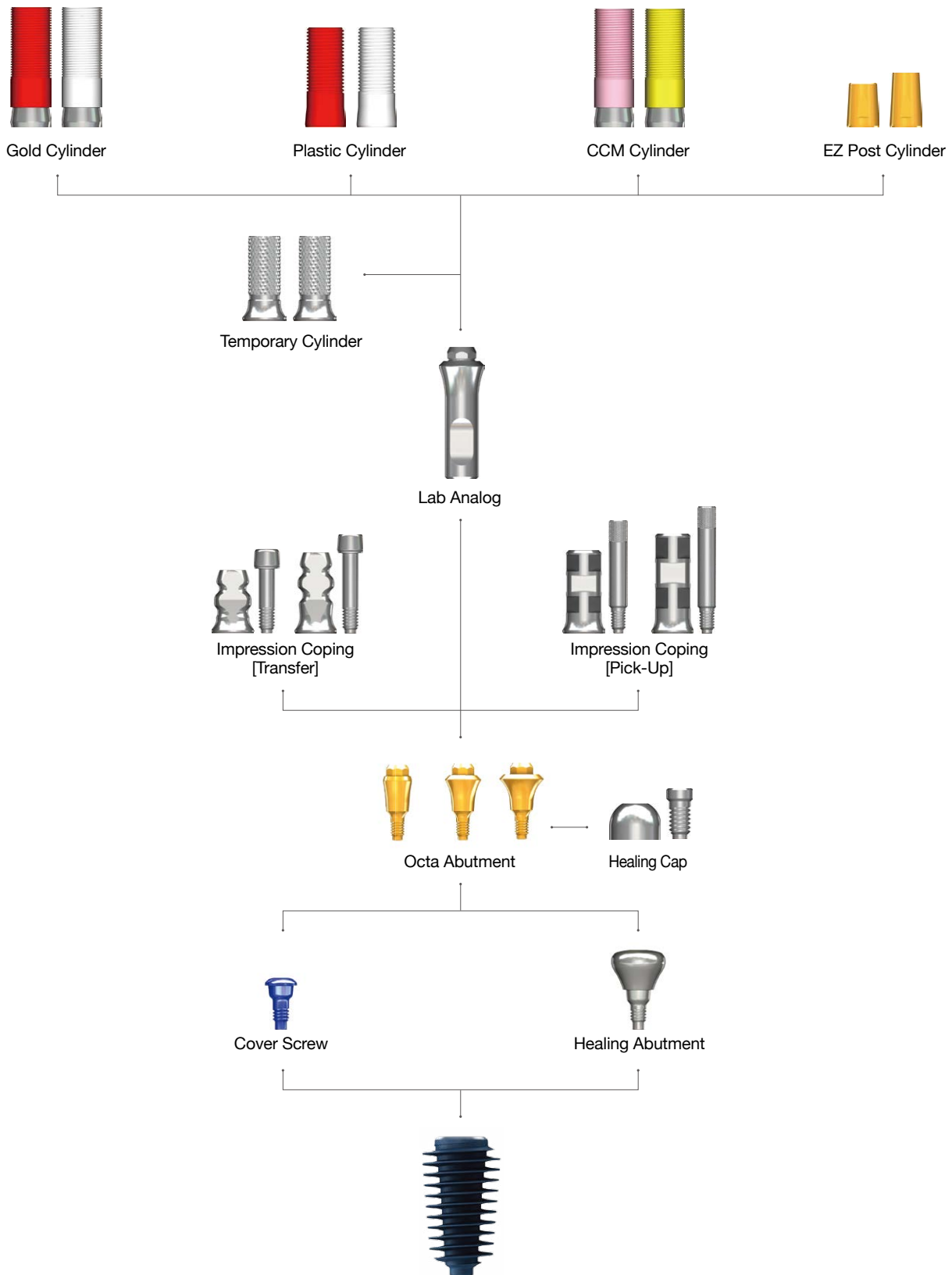

➔ Components for Octa Abutment (Continued)

Octa Abutment

- Used in manufacturing multiple screw-retained prosthetics.
- Recommend torque : 35Ncm
- Maximum path angle : 70°

Profile Diameter	Cuff Height (mm)	Ref.C
Ø4.0	1	AANOAF4010
	2	AANOAF4020
	3	AANOAF4030
	4	AANOAF4040
	5	AANOAF4050
Ø5.0	1	AANOAF0010
	2	AANOAF0020
	3	AANOAF0030
	4	AANOAF0040
	5	AANOAF0050
Ø6.0	1	AANOAF6010
	2	AANOAF6020
	3	AANOAF6030
	4	AANOAF6040
	5	AANOAF6050

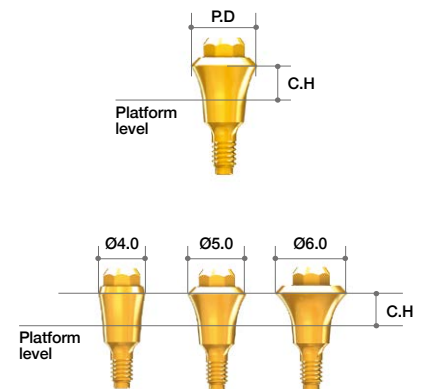

Healing Cap

- Cylinder Screw(IRCS200) included.
- Protects Octa Abutment and minimizes irritation to tongue and oral mucosa.

Profile Diameter	Ref.C
Ø4.0	AANOHC4000T
Ø5.0	IHC400T
Ø6.0	AANOHC6000T



➔ Components for Octa Abutment

Impression Coping

(Transfer)

- Guide Pin(AAOTGP10 / AAOTGP12) included.

- Should be tightened with Impression Driver (Page.256)
- Special impression coping screw which can be used with a 1.2mm hex driver is available on request.

Profile Diameter	Height (mm)	Type	Ref.C
Ø4.0	7.5	Octa	AAOIT04010T
		Non-Octa	AAOITN4010T
	9.5	Octa	AAOIT04012T
		Non-Octa	AAOITN4012T
Ø5.0	7.5	Octa	AAOIT05010T
		Non-Octa	AAOITN5010T
	9.5	Octa	AAOIT05012T
		Non-Octa	AAOITN5012T
Ø6.0	7.5	Octa	AAOIT06010T
		Non-Octa	AAOITN6010T
	9.5	Octa	AAOIT06012T
		Non-Octa	AAOITN6012T

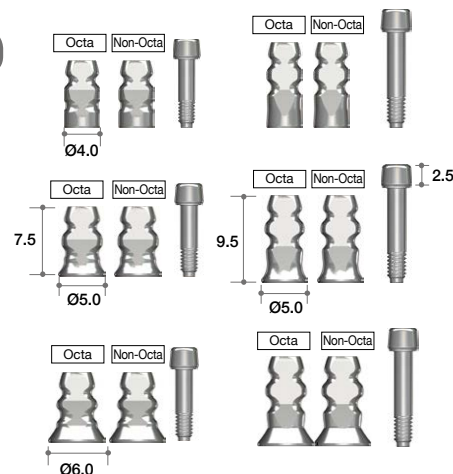

Impression Coping

(Pick-Up)

- Guide Pin(AAOPGP10 / AAOPGP12) included.

Profile Diameter	Height (mm)	Type	Ref.C
Ø4.0	10.0	Octa	AAOIPO4010T
		Non-Octa	AAOIPN4010T
	12.0	Octa	AAOIPO4012T
		Non-Octa	AAOIPN4012T
Ø5.0	10.0	Octa	AAOIPO5010T
		Non-Octa	AAOIPN5010T
	12.0	Octa	AAOIPO5012T
		Non-Octa	AAOIPN5012T
Ø6.0	10.0	Octa	AAOIPO6010T
		Non-Octa	AAOIPN6010T
	12.0	Octa	AAOIPO6012T
		Non-Octa	AAOIPN6012T

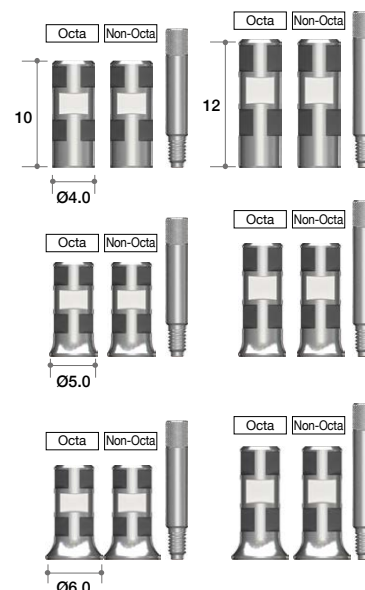

Lab Analog

Profile Diameter	Ref.C
Ø3.8	AANOLA4000
Ø4.8	IOA300
Ø5.8	AANOLA6000

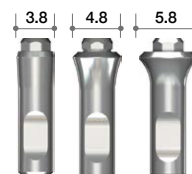

Temporary Cylinder

- Cylinder Screw(IRCS200) included.

- Recommend torque : 25Ncm

Profile Diameter	Type	Ref.C
Ø4.0	Octa	AANOTCO4010T
	Non-Octa	AANOTCN4010T
Ø5.0	Octa	AANOTCO5010T
	Non-Octa	AANOTCN5010T
Ø6.0	Octa	AANOTCO6010T
	Non-Octa	AANOTCN6010T

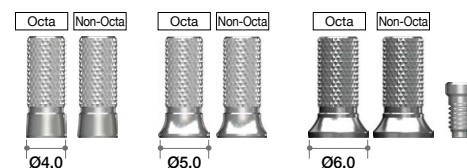

EZ Post Cylinder

- Cylinder Screw(IRCS200) included.

- Recommend torque : 35Ncm

Profile Diameter	Post Height(mm)	Type	Ref.C
Ø4.0	5.5	Octa	AAOECO4005T
	7.0		AAOECO4007T
	5.5	Non-Octa	AAOECN4005T
	7.0		AAOECN4007T
Ø5.0	5.5	Octa	AAOECO5005T
	7.0		AAOECO5007T
	5.5	Non-Octa	AAOECN5005T
	7.0		AAOECN5007T
Ø6.0	5.5	Octa	AAOECO6005T
	7.0		AAOECO6007T
	5.5	Non-Octa	AAOECN6005T
	7.0		AAOECN6007T

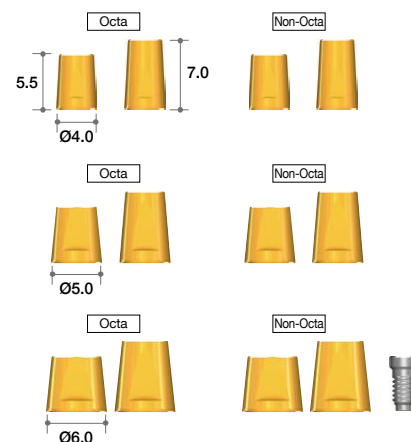

➔ Components for Octa Abutment

Gold Cylinder

- Cylinder Screw(IRCS200) included.

- For customizing abutment for screw retained multi-unit restoration.
- Available in both octa(red) and non-octa(white).
- Melting point of gold alloy : 1063°C
- Threaded sleeves allow better retention of resin or wax.
- Available in three diameters (Ø4.0, 5.0, 6.0).
- Recommend torque : 30Ncm

Profile Diameter	Type	Ref.C
Ø4.0	Octa	AANGCO4000T
	Non-Octa	AANGCN4000T
Ø5.0	Octa	IOGO100T
	Non-Octa	IIGN100T
Ø6.0	Octa	AANGCO6000T
	Non-Octa	AANGCN6000T

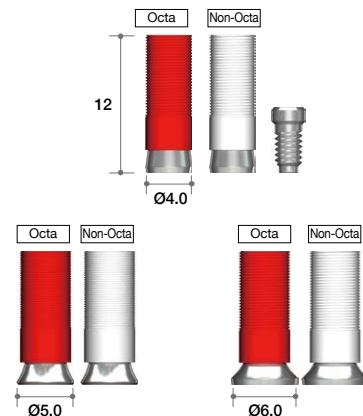

CCM Cylinder

- Cylinder Screw(IRCS200) included.

- Threaded sleeves allow a better retention of resin or wax.
- Available in both octa (pink) and non-octa (yellow) and three diameters (Ø4.0, 5.0, 6.0).
- Recommend torque : 35Ncm
- Melting temperature of CCM : 1300~1400°C
- Can be casted with non-precious alloys (Ni-Cr, Cr-Co alloys).

Profile Diameter	Type	Ref.C
Ø4.0	Octa	AANCCO4000T
	Non-Octa	AANCCN4000T
Ø5.0	Octa	AANCCO5000T
	Non-Octa	AANCCN5000T
Ø6.0	Octa	AANCCO6000T
	Non-Octa	AANCCN6000T

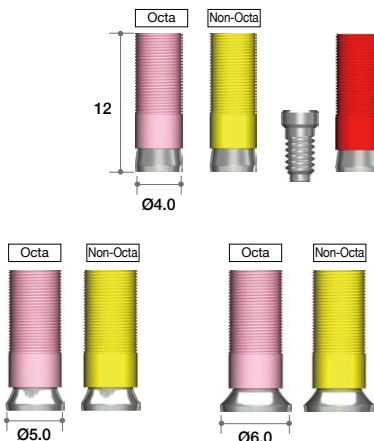

Plastic Cylinder

- Cylinder Screw(IRCS200) included.

- Economical option.
- Used for customizing abutment a screw retained multi-unit restorations.
- Available in both octa (red) and non-octa (white)
- Threaded sleeves allow a better retention of resin or wax.
- Recommend torque : 25Ncm

Profile Diameter	Type	Ref.C
Ø4.0	Octa	AAOTCO4010T
	Non-Octa	AAOTCN4010T
Ø5.0	Octa	IOPH100T
	Non-Octa	IOPN100T
Ø6.0	Octa	AAOTCO6010T
	Non-Octa	AAOTCN6010T

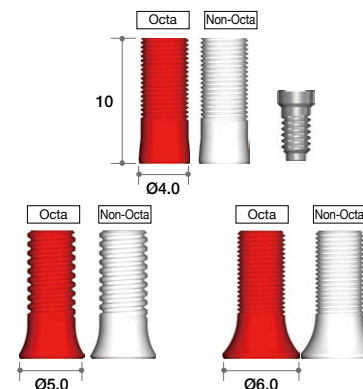

II. Abutment Level Prosthesis

3-1. Multi-unit Abutment & Components (All-on-4) (N_Type)

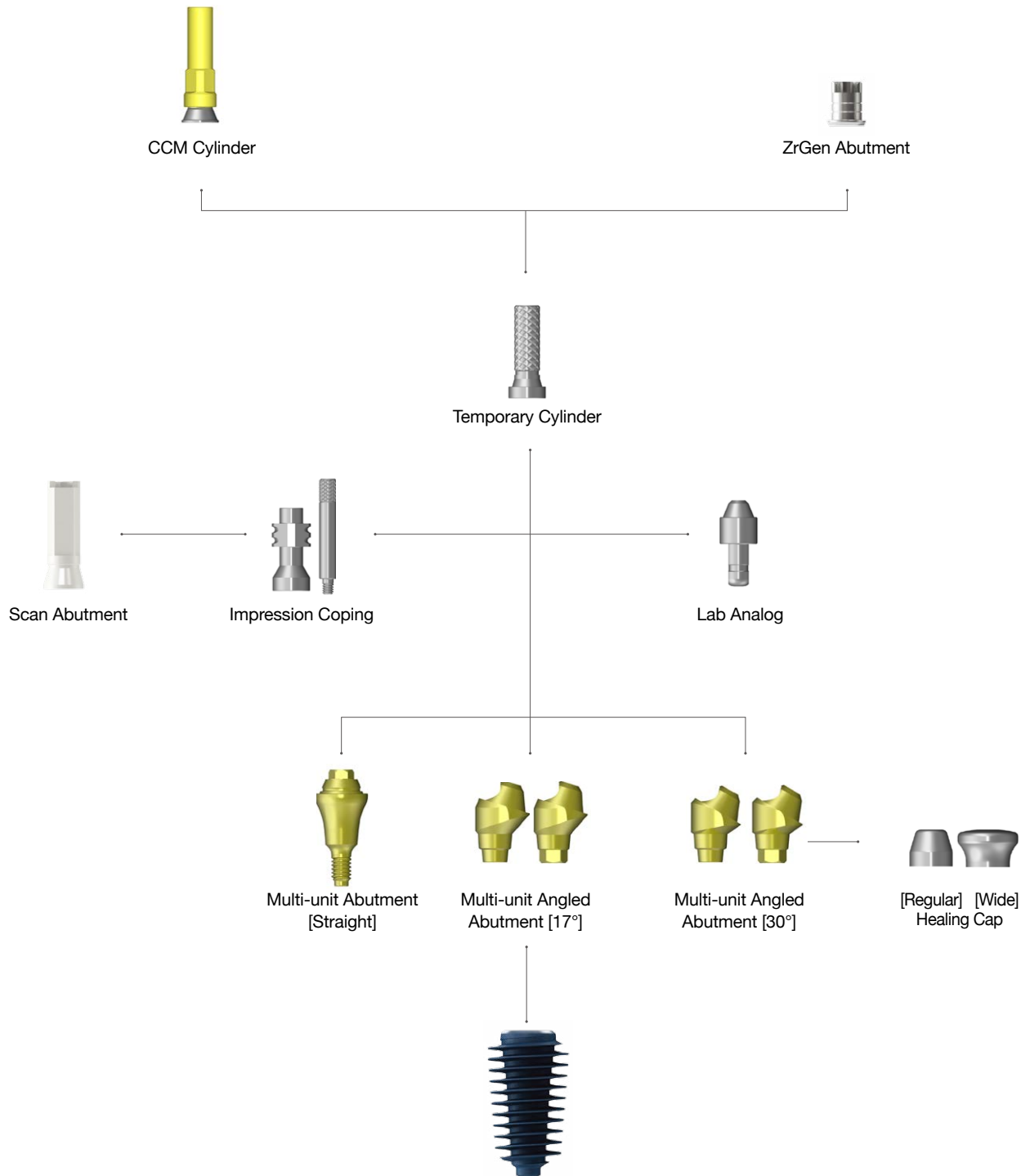

►► Multi-unit Abutment™

Multi-unit Abutment Design Concept

MegaGen Implant develops the special abutment named as Multi-unit Abutment, which can be the solution for the edentulous patients. With 4 fixtures placed into patient's ridge and a hybrid denture on those four fixtures, a patient can recover his or her dental condition almost completely. In most cases, Multi-unit Abutments work in a set of 2 x straight type abutment for anterior position and 2 x angled type abutment on posterior position.

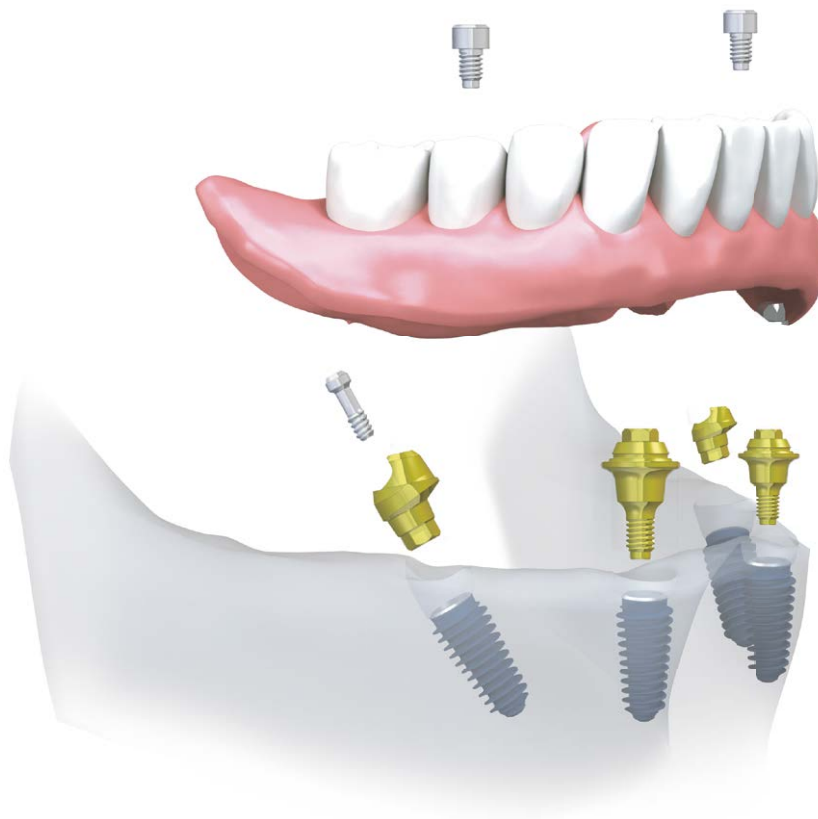

Features

You could see how Multi-unit Abutment functions and what benefits you could get from Multi-unit Abutment are as the followings:

- 2 fixtures which are slantly implanted on posterior position are osseointegrated with cancellous bone. These fixtures function as dispersing vertical load on alveolar bone.
- Multi-unit Abutment is only 4 fixtures + 4 abutments. It means that dental surgeon has enough places for surgery. Therefore, it will be easy to find and place 4 fixtures into ridge where abundant cancellous bone exists.
- A doctor can use graft bone material if a patient doesn't have enough alveolar bone. However, the slantly placed fixtures can overcome the patient's insufficient bone by getting good holding strength with this angulation.
- In addition, these angulated fixtures can avoid touching important anatomies, such as mandibular nerve and maxillary sinus.
- All on 4 technique is also possible to do guided surgery using R2GATE Guide with a diagnosis from R2GATE.

►► Multi-unit Abutment N Type

The solution for the edentulous patients

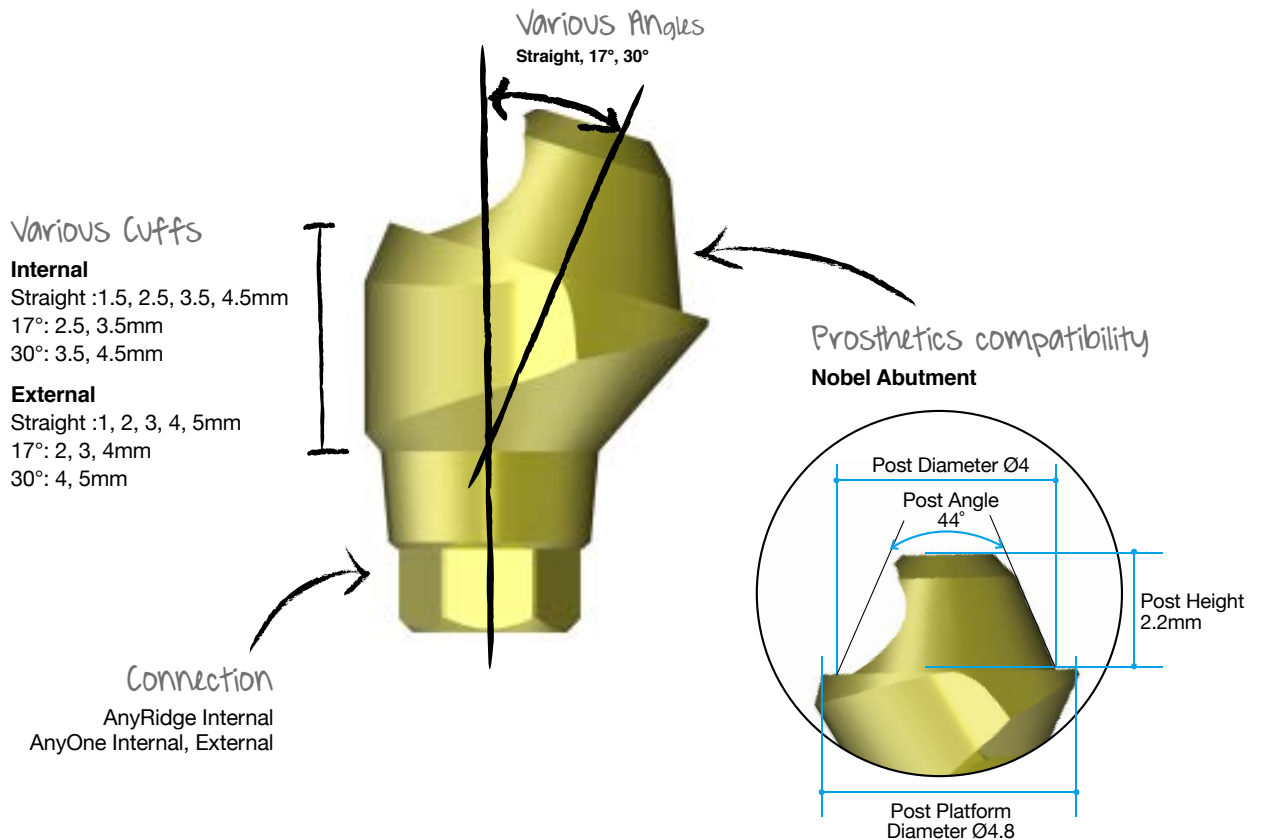

Benefit

1. Easy and economical treatment solution for compromised edentulous cases.
2. Expensive and time consuming bone graft may not be necessary.
3. Multiple angles (0°, 17°, 30°) support different implant insertion paths.
4. Universally compatible with other Multi-unit systems.

Available implant System

- AnyRidge Internal
- AnyOne Internal
- AnyOne External

Compatibility with others' Multi-unit level prosthetic components

- ✓ Post Height
- ✓ Post Diameter
- ✓ Post Angle
- ✓ Abutment Angle
- ✓ Cuff Height

➔ Multi-unit Abutment

Multi-unit Abutment [AR] - Straight

- MUA Straight Carrier (MUASC) included
- Recommend torque : 35Ncm

Cuff Height (mm)	Type	Ref.C
1.5	1-piece (M1.8)	MUAARN0015C
2.5		MUAARN0025C
3.5		MUAARN0035C
4.5		MUAARN0045C

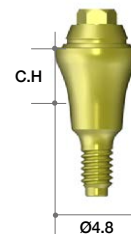

Multi-unit Angled Abutment [AR] - 17°

- MUA Screw (MUAARS) included
- MUA Angled Carrier (MUAAC) included
- Recommend torque : 25Ncm

Cuff Height (mm)	Type	Ref.C
2.5	Hex	MUAARH1725LC
3.5		MUAARH1735LC
4.5		MUAARH1745LC
2.5	Non-Hex	MUAARN1725LC
3.5		MUAARN1735LC
4.5		MUAARN1745LC

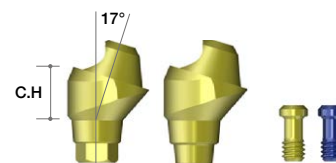

Multi-unit Angled Abutment [AR] - 30°

- MUA Screw (MUAARS) included
- MUA Angled Carrier (MUAAC) included
- Recommend torque : 25Ncm

Cuff Height (mm)	Type	Ref.C
3.5	Hex	MUAARH3035LC
4.5		MUAARH3045LC
3.5	Non-Hex	MUAARN3035LC
4.5		MUAARN3045LC

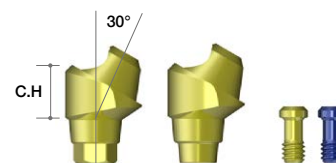

➔ Components for Multi-unit Abutment (Continued)

Impression coping (Pick-up)

- Guide pin (MUAGP) included
- Use to take an impression at the abutment level.
- Open tray method.

Connection	Ref.C
Non-Hex	MUAICT

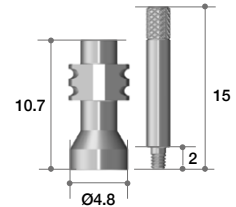

Lab Analog

- Use to duplicate the Multi-unit abutment in the working model.
- Available to use as a RP Analog for 3D printed working model.

Head form	Ref.C
Multi-unit Abutment(Nobel)	MUALA

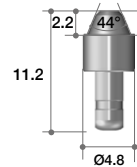

Temporary Cylinder

- Cylinder Screw (MUAS) included
- Use for fabricating acrylic provisional restoration.
- Grooves on the post cylinder allow storing resin adhesion.
- Back-up screw is included.
- Recommend torque : 15Ncm

Connection	Ref.C
Non-Hex	MUATCL

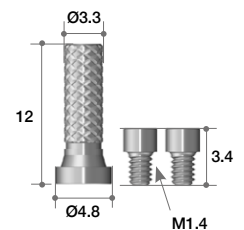

CCM Cylinder

- Cylinder Screw (MUAS) 2EA included
- Use for fabricating screw retained prostheses with metal reinforced or bar structured overdentures.
- Available to cast with non-precious dental alloys (Ni-Cr, Cr-Co alloys)
- Melting temperature of CCM base: 1300~1400°C
- Back-up screw is included.
- Recommend torque : 15Ncm

Connection	Ref.C
Non-Hex	MUACCML

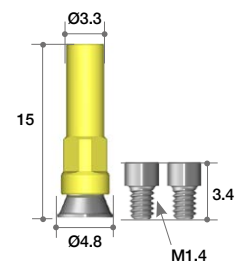

➔ Components for Multi-unit Abutment

Healing Cap

- Cylinder Screw (MUAS) 2ea included
- The size of healing cap can be selected depending on soft tissue volume or type of restorations.

Type	Ref.C
Regular	MUAHCL
Wide	MUAHCWL

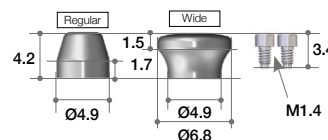

Healing Cap Set reference code

Order code : Add "P" after the existing reference code

Ex) MUAHCL → MUAHCP



Try-in Abutment

- Cuff height is indicated with laser markings
- Straight 17°, 30°
- Non-hex type

Angle	Cuff Marking	Ref.C
Straight	1.5 / 2.5 / 3.5 / 4.5	MUTIAAR00C
17°	2.5 / 3.5 / 4.5	MUTIAAR17C
30°	3.5 / 4.5	MUTIAAR30C

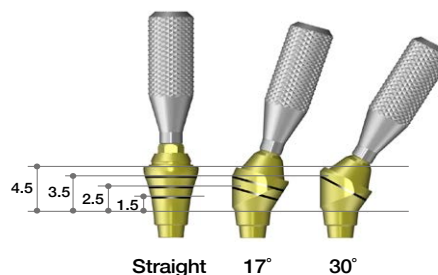

Try-in Abutment Set reference code

Order code : MUTIAAR00P



- * Available Systems : AnyRidge, AnyOne Internal, AnyOne External
- * Kit contains Straight, 17° and 30° type of Try-in Abutments (1 each)



Multi-unit Driver

- Use to torque straight type Multi-unit Abutments.
- Use with a torque wrench (ref code: **MTW300A**)

Hex	Length	Ref.C
2.0	10	MUD10

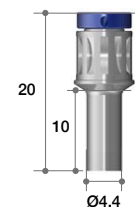

Right Angle Driver

- Use to torque straight type Multi-unit Abutments.
- Use with latch-type handpiece.
- Use with Meg-TORQ (ref code: **MEG_TORQ**)

Hex	Length	Ref.C
2.0	10	MURAD10

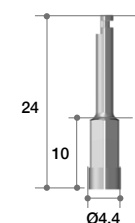

Hand Driver

- Use for abutment screw with 1.2 hex hole.
- Use up to 15° divergent.
- It should use under 30Ncm torque.

Hex	Length	Ref.C
1.2	20	MUHD1220

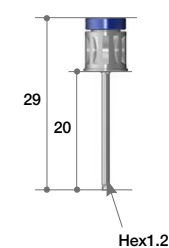

Removal Driver

- Use for abutment screw with 1.2 hex hole.
- Use up to 15° divergent.
- Exclusively for AnyRidge system.
- It should use under 30Ncm torque.

Hex	Length	Ref.C
1.2	20	MUARD20

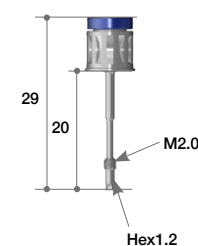

► Screw & Abutment Tightening Torque Guide

- Abutment Screw (M1.8 & M2.0) : 25Ncm
- Cylinder Screw (M1.4) : 15Ncm
- Straight Abutment (M1.8 & M2.0) : 35Ncm

Instruction for removing abutment screw from Multi-unit abutment [Exclusively for AnyRidge system]

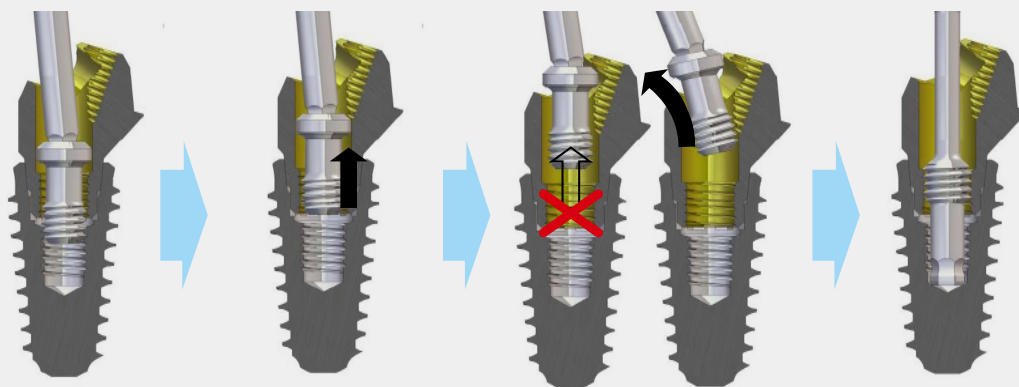

1. Completely unscrew abutment screw by rotating it counterclock wise (approximately 4 rotations are required). It should sue with a Hand Driver (ref code: MUHD1220)

2. Pull the Hand Driver up straight until it is visible through abutment crew hole. Shaking left and right may be required if the screw becomes stuck inside of the abutment hole.

3. Slightly rotate the screw to the main access hole. Otherwise the screw could fall back into the screw hole due to disturbance of abutment structure.

4. Remove abutment with the Removal Driver (ref code: MUARD20) by rotating it clockwise.

Driver Tightening Torque Guide

1. Multi-unit Abutment Remover Driver



2. Multi-unit Hand Driver



- Excessive torque more than 30Ncm may cause fracturing of the driver.
- Straight type Multi-unit abutment needs to use the Multi-unit Driver that is provided in the starting package. (ref code: MUD10)
- **Strongly recommended to pick up the abutment screw by pressing the Hand Driver to remove the abutment screw from the Multi-unit abutment.**

➔ Components for Multi-unit Abutment

Surgical Guide

- The distance between the lines is 7mm
- Put center pin after initial drilling at the centric of arch.

Angle	Marking Length (mm)	Ref.C
30°	7	MUSG70

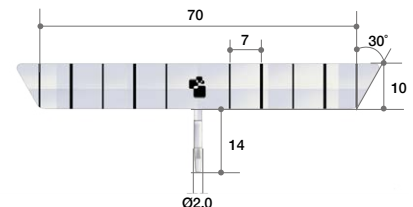

▶▶ How to use Surgical Guide

- ※ As Canine and second premolar are most commonly used, the surgical guide has thicker lines for easier identification.
- ※ The surgical guide is able to use for first molar depending on surgical plan.

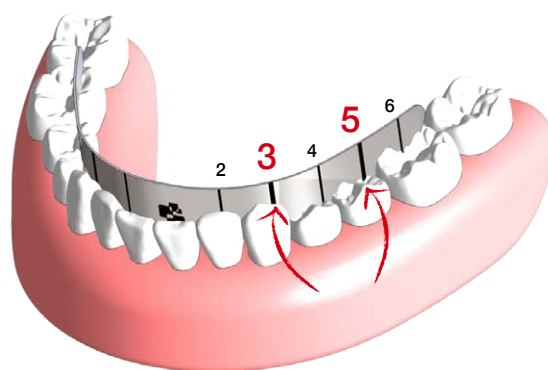
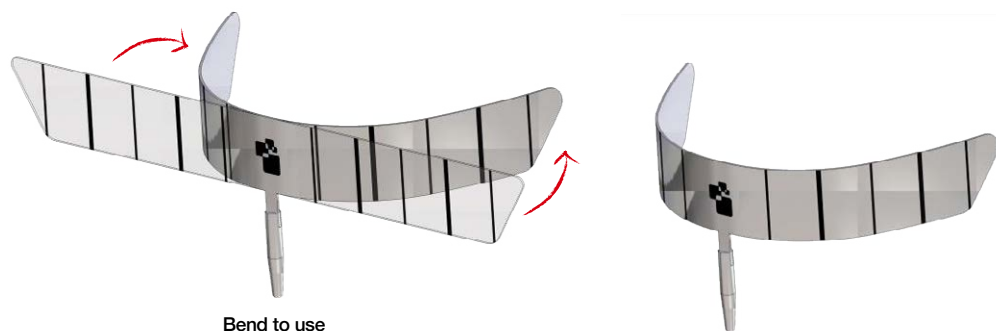

► Multi-unit Abutment Set Contents

Multi-unit Abutment Healing cap type Set reference code

Order code : Add "HP" after the existing reference code

Ex) MUAARH1725LC → MUAARH1725 HP

Multi-unit Abutment CCM type Set reference code

Order code : Add "P" after the existing reference code

Ex) MUAARH1725LC → MUAARH1725 P

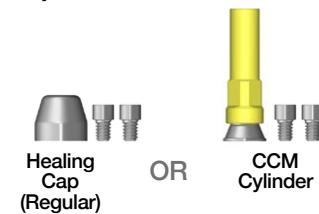
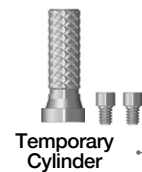
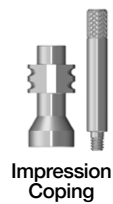
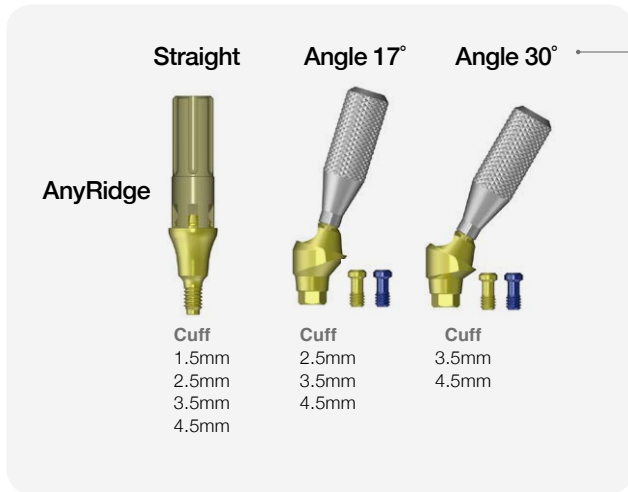

▶▶ Starting Package Contents



Type		Ref.C
Healing Cap	Hex	SKARHN3000H
	Non Hex	SKARNN3000H
CCM Abutment	Hex	SKARHN3000
	Non Hex	SKARNN3000

Straight 8set (2set x 4kind of cuff)	Angle 17° 6set (2set x 3kind of cuff)	Angle 30° 4set (2set x 2kind of cuff)
<p>Multi-unit Abutment with *carrier</p> <p>* MUA carrier is used to pick-up an abutment to the patient's mouth, and check its insertion angle.</p>		
<p>Healing Cap (Regular) or CCM Cylinder</p> <p>Temporary Cylinder</p> <p>Lap Analog</p> <p>Impression Coping</p>		

Surgical Instrument

Multi-unit Driver Right Angle Driver Hand Driver Removal Driver

Healing Cap 2set

Regular

Wide

Try-in Abutment 1set
(Straight, 17°, 30° each 1ea)

Surgical Guide 2ea

►► Surgical Protocol

Conventional Surgery

1. Initial drilling

For placement of center pin after initial drilling in the centric of the arch. The drilling hole should be in lingual area of the arch to ensure the best result.

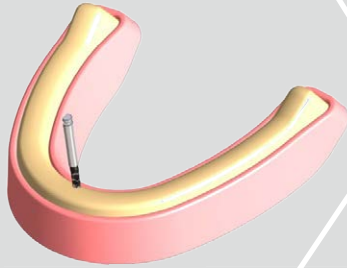

2. Guide Bending & Position

Bend according to the patient's arch.

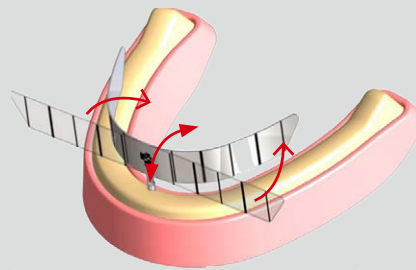

7. Tightening the Abutment

Abutment Screw tightening Torque : 25Ncm

After connecting Abutment Screw, remove Carrier from Abutment. For 17° abutment, you need to tighten it by tilting Driver about 5°. Connect Abutment and check the path using Carrier.

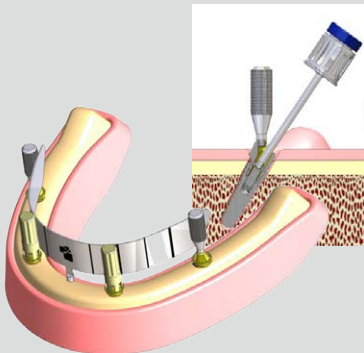

Straight Abutment tightening Torque : 35Ncm

After removing Carrier, connect Abutment to the Fixture using Right Angle Driver or MUA Driver.

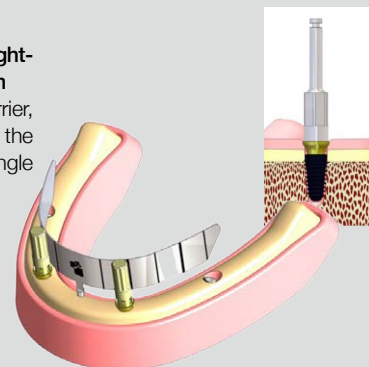

8. Impression

Take an impression with an individual tray. (Open tray method is strongly recommended to avoid any error in the future.)

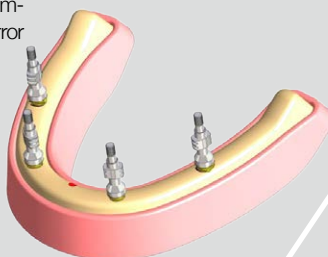

9. Healing Cap

Cylinder Screw tightening Torque : 15Ncm

Place Healing Cap on top of Multi-unit abutment, and connect Cylinder Screw with the Hand Driver.

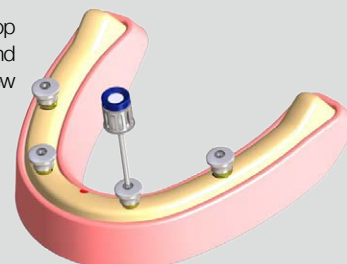

3. Drilling

Drill according to the surgical plan.

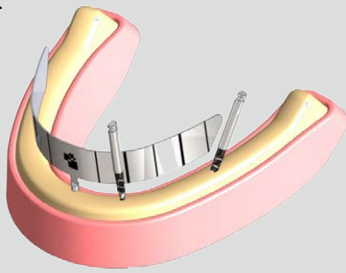

4. The fixture is implanted

Place implant fixtures according to the surgical plan and do not exceed torque value (60Ncm)

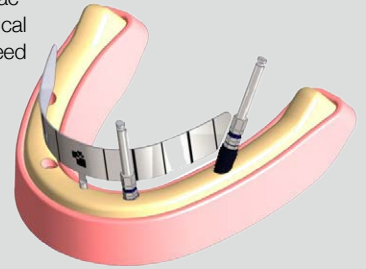

6. Abutment Selection

Select the appropriate set after checking the angulation and cuff height that were measured with the Try-in abutment. Connect the abutment onto the fixture and check the angulation and the cuff height.



5. Try-in Abutment

Using the laser marking on the Try-in abutment, select the appropriate cuff height and angulation of Multi-unit abutments.

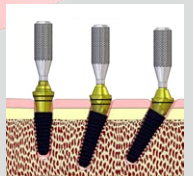
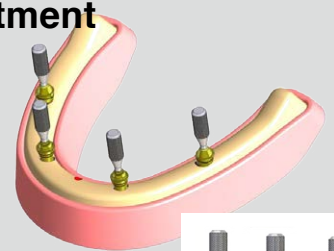

10. Suture

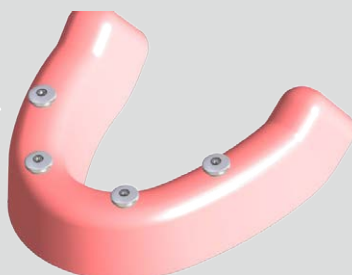

►► Surgical Protocol Guided Surgery

1. Guide

Place a R2GATE Guide.

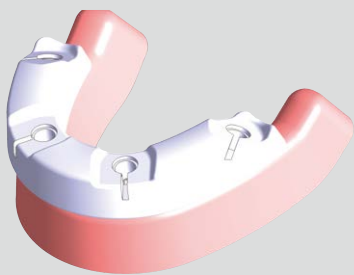

2. Narrow Crest Drill

For the cases with narrow ridge or placing a fixture slanted on the lingual side, you can flatten the surface and drill stably without slipping

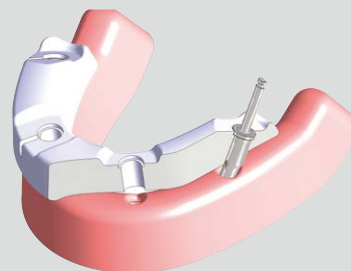

8. Setting Temporary and Denture

Reline the temporary denture with resin to fill the space around the Temporary Cylinder.



7. Connect Temporary Cylinder in the front

Connect the Temporary Cylinders in the front. Make sure that holes in the denture are free from any contact with the Temporary Cylinder. Adjust the holes until there is no contact between the denture and the Temporary Cylinder.
*If the Temporary Cylinder is fixed using Guide Pin, resin flow into access hole will be prevented.

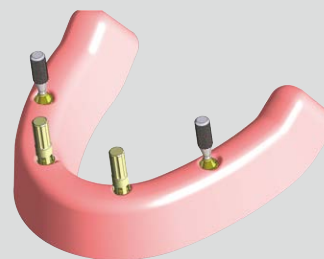

9. Connect Temporary Cylinder in the back

Connect rest of the Temporary Cylinders in the back, make sure that the holes in the denture are free from any contact with the Temporary Cylinder. Adjust the holes until there is no contact between the denture and the Temporary Cylinder.



10. Setting Temporary and Denture

All temporary cylinders are picked up in the denture with resin.



3. Drilling

Drill according to the drilling sequence.

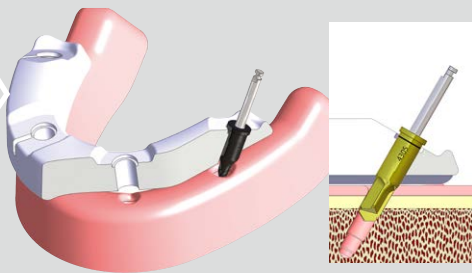

4. Fixture Placement

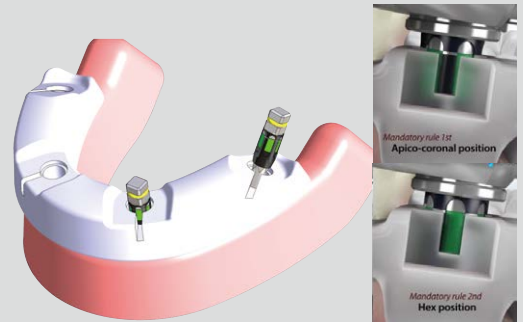

6. Abutment Selection

Select the appropriate set after checking the angulation and cuff height that were measured with the Try-in abutment. Connect the abutment onto the fixture and check the angulation and the cuff height.



5. Try-in Abutment

Using the laser marking on the Try-in abutment, select the appropriate cuff height and angulation of Multi-unit abutments.

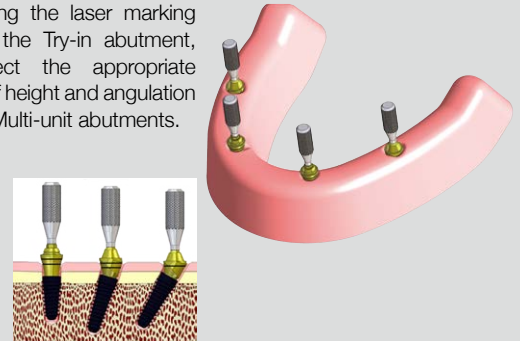

11. Temporary Fixation

Remove Denture and fill up the bottom and other non-resin filled parts with resin and completely fix Temporary Cylinder.



12. Tighten the Denture

Cylinder Screw tightening Torque : 15Ncm
Set Denture onto Multi-unit Abutment and tighten cylinder



13. Finish

Close Hole using EZ Seal and finalize the surgery.



►► Multi-unit Abutment S Type

The solution for the edentulous patients

For the design concept and variable of the Multi-unit Abutment

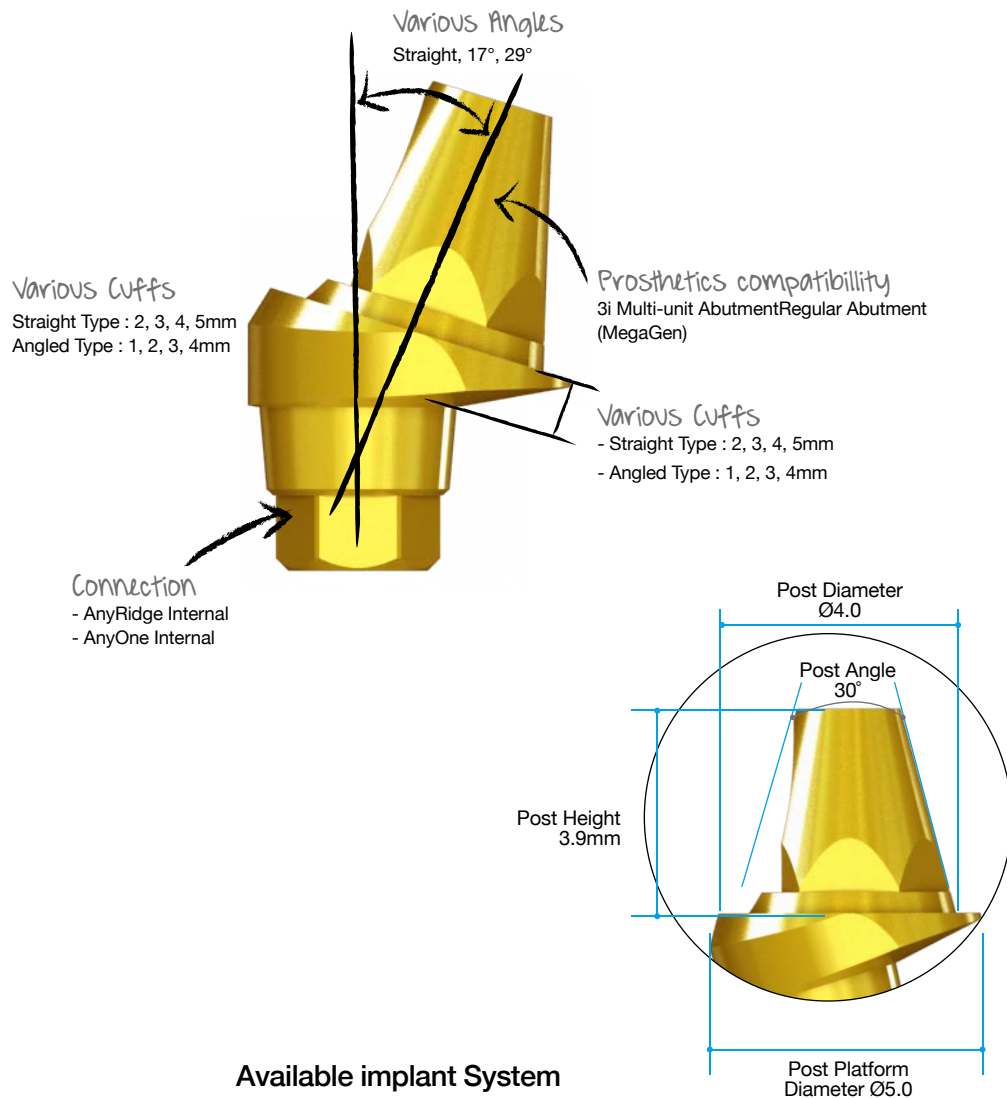

Benefit

1. Retrievability means that doctor can change or retrieve the final prosthetics easily.
2. Two types of angulation : 17°, 29°. It means that doctor has various options to angle.
3. Various cuff heights (1~5mm) : Doctor can have flexibility on the depth of fixture placement.
4. MegaGen's Multi-unit Abutment is perfectly compatible with the prosthetic components of Multi-unit Abutment of 3i implant, and Regular Abutment of MegaGen's Exfeel External system.

Available implant System

- AnyRidge Internal
- AnyOne Internal

II. Abutment Level Prosthesis

3-2. Multi-unit Abutment & Components

(All-on-4) (S-Type)

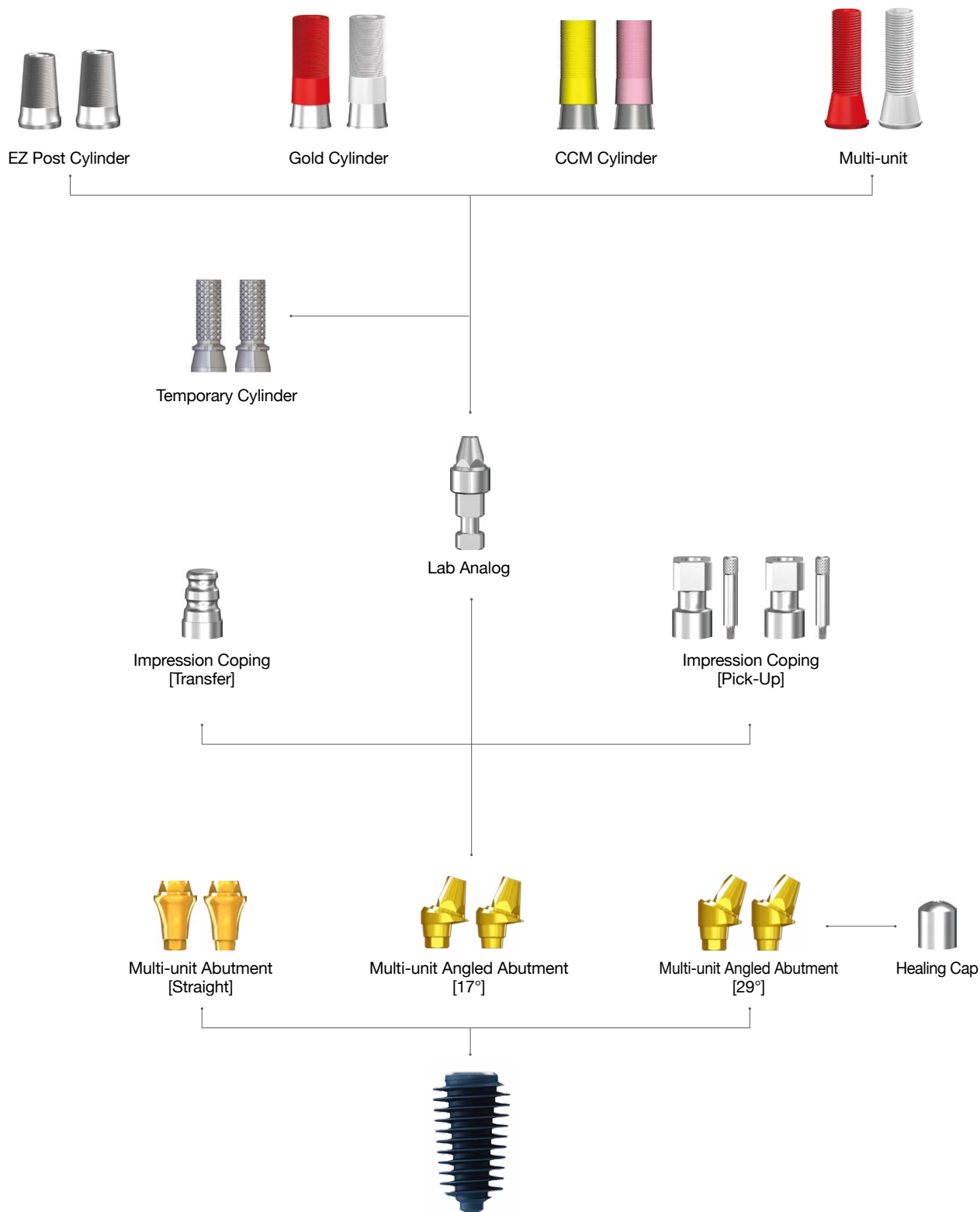

➔ Multi-unit Abutment

Multi-unit Abutment

(Straight)

- Multi-unit Abutment Screw(AANMUS20) included.
- Use with Multi-unit Driver.
- TCMMUDS20 (short)
- TCMMUDL20 (long)
- Recommend torque : 35Ncm

Cuff Height (mm)	Type	Ref.C
2.0	Hex	AANMUH5020T
3.0		AANMUH5030T
4.0		AANMUH5040T
5.0		AANMUH5050T
2.0	Non-Hex	AANMUN5020T
3.0		AANMUN5030T
4.0		AANMUN5040T
5.0	AANMUN5050T	

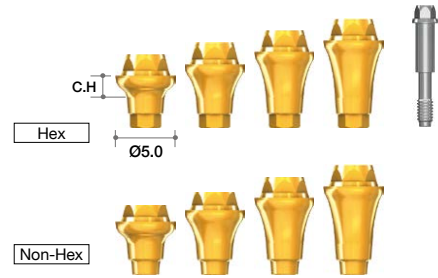

Multi-unit Angled Abutment (17°)

- Multi Post Screw(MUMSF/MUMST) included.
- Recommend torque : 35Ncm

Cuff Height (mm)	Type	Ref.C
1.0	Hex	AANMUH50117L
2.0		AANMUH50217L
3.0		AANMUH50317L
4.0		AANMUH50417L
1.0	Non-Hex	AANMUN50117L
2.0		AANMUN50217L
3.0		AANMUN50317L
4.0	AANMUN50417L	

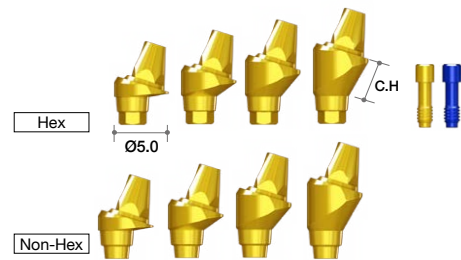

Multi-unit Angled Abutment (29°)

- Multi Post Screw(MUMSF/MUMST) included.
- Recommend torque : 35Ncm

Cuff Height (mm)	Type	Ref.C
1.0	Hex	AANMUH50129L
2.0		AANMUH50229L
3.0		AANMUH50329L
4.0		AANMUH50429L
1.0	Non-Hex	AANMUN50129L
2.0		AANMUN50229L
3.0		AANMUN50329L
4.0	AANMUN50429L	

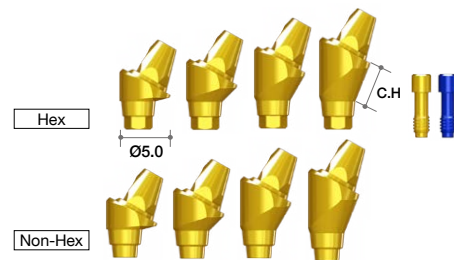

➔ Components for Multi-unit Abutment (Continued)

Lab Analog

Profile Diameter	Ref.C
Ø4.8	RELA300



Temporary Cylinder

- Cylinder Screw (TASH140) included
- Recommend torque : 15Ncm

Profile Diameter	Type	Ref.C
Ø4.8	Hex	ETH100T
	Non-Hex	ETN100T

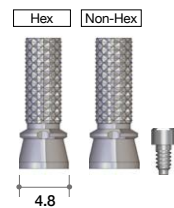

EZ Post Cylinder

- Cylinder Screw (TASH140) included
- Recommend torque : 15Ncm

Profile Diameter	Type	Ref.C
Ø5.0	Hex	RCA900T
	Non-Hex	RCA800T

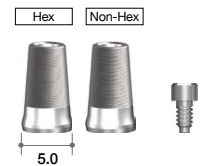

Healing Cap

Profile Diameter	Ref.C
Ø5.0	REC600



Impression Coping (Transfer)

Profile Diameter	Ref.C
Ø4.8	RITE480



Impression Coping (Pick-Up)

- Guide Pin (RICG150) included

Height (mm)	Type	Ref.C
9.4	Hex	RIEH480T
	Non-Hex	RIEN480T



➔ Components for Multi-unit Abutment

Gold Cylinder

- Cylinder Screw (TASH140) included
- Useful to make a customized abutment in difficult situations.
- Precious and non-precious alloys.
- Melting point of gold alloy : 1063°C
- Threaded sleeves for convenient Resin / Wax-up.
- Recommend torque : 15Ncm

Profile Diameter	Sleeve Color	Ref.C
Ø5.0	Red	REGC200T
	White	REGC100T



CCM Cylinder

- Cylinder Screw (TASH140) included
- Useful to make a customized abutment in difficult situations.
- Can be casted with non-precious alloys (Ni-Cr, Cr-Co alloys).
- Non-precious melting temperature : Depends on Manufacturer
- Threaded sleeves for convenient Resin / Wax-up.
- Melting temperature of CCM : 1300~1400°C
- Recommend torque : 15Ncm

Profile Diameter	Sleeve Color	Ref.C
Ø4.8	Pink	RCA5013HT
	Yellow	RCA5013NT

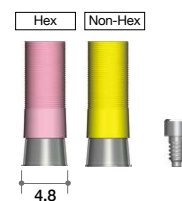

Plastic Cylinder

- Cylinder Screw (TASH140) included
- Recommend torque : 15Ncm

Profile Diameter	Sleeve Color	Ref.C
Ø5.2	Red	RPEH100T
	White	RPEN100T



II. Abutment Level Prosthesis

4. Flat Abutment & Components

: The main advantage of this Flat Abutment is the freedom on angulation.

Flat Abutment can cover any angulation problems.

: Only for multiple (Cannot be used for single implant)

: Only with screw-retained prosthetics.

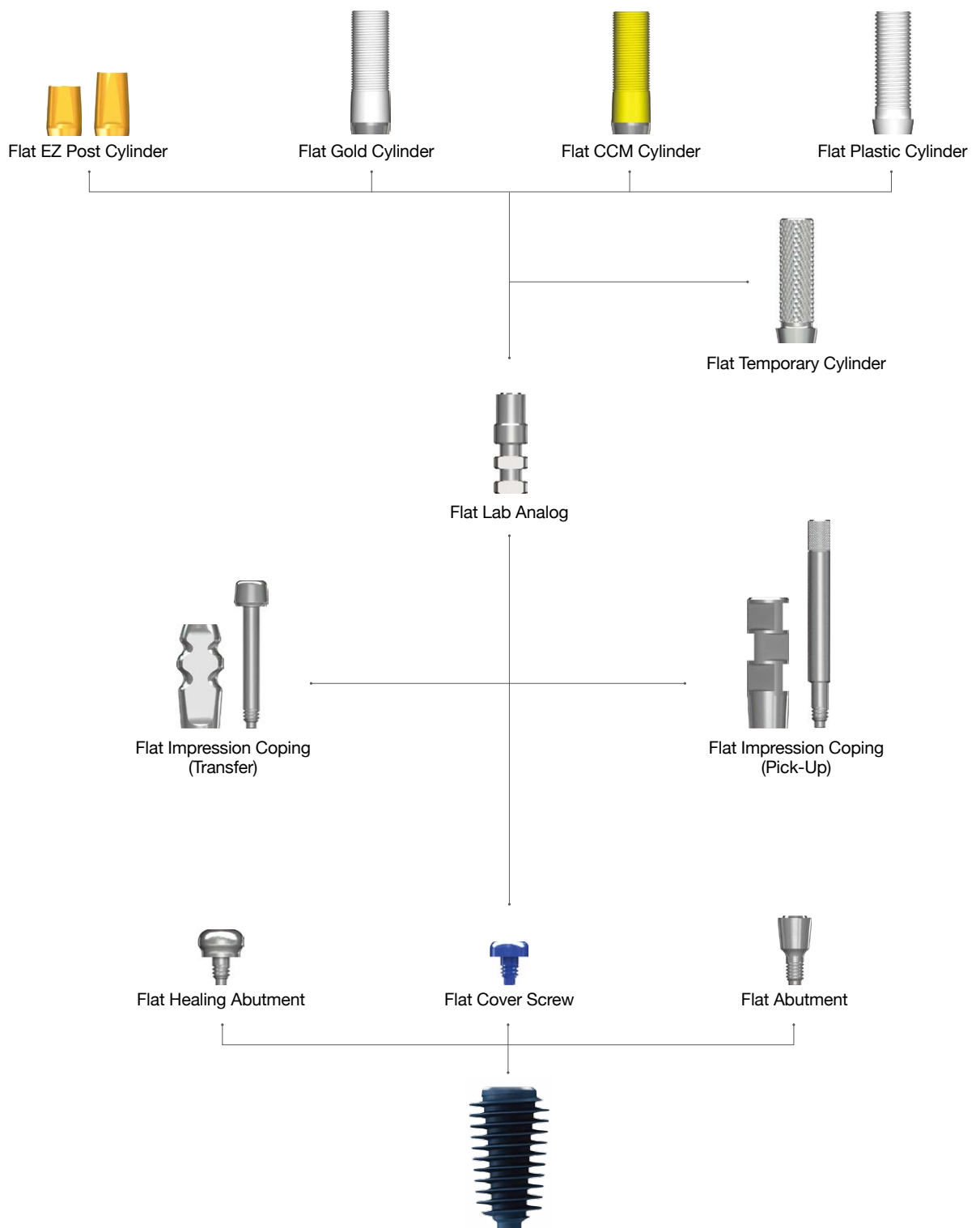

➔ Components for Flat Abutment (Continued)

Flat Abutment

- Use Hand Driver (1.6 Hex)
- Recommend torque : 25Ncm

Profile Diameter	Cuff Height (mm)	Ref.C
Ø3.5	1	AANFAL3510
	2	AANFAL3520
	3	AANFAL3530
	4	AANFAL3540
	5	AANFAL3550



Flat Cover Screw

- Recommend torque : by hand (5 - 8Ncm)

Profile Diameter	Ref.C
Ø3.5	FCS3510

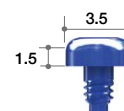

Flat Healing Abutment

- Recommend torque : by hand (5 - 8Ncm)

Height(mm)	Ref.C
2	FHA402
3	FHA403
4	FHA404



Flat Impression Coping (Transfer)

- Guide Pin (FGPT) included.
- Should be tightened with Impression Driver
- Special impression coping screw which can be used with a 1.2mm hex driver is available on request.

Profile Diameter	Height (mm)	Ref.C
Ø3.5	9.5	FIT4012T

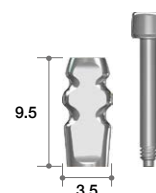

Flat Impression Coping (Pick-Up)

- Guide pin (FGPP15) included.

Profile Diameter	Height (mm)	Ref.C
Ø3.5	12	FIP4012T

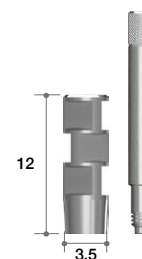

Flat Lab Analog

Profile Diameter	Height (mm)	Ref.C
Ø3.5	12	FLA3512

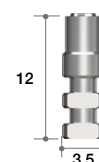

Flat Temporary Cylinder

- Flat Cylinder Screw (FAS) included.
- Recommend torque : 15Ncm

Profile Diameter	Ref.C
Ø4.0	FTC4012T



Flat EZ Post Cylinder

- Flat Cylinder Screw (FAS) included.
- Recommend torque : 25Ncm

Height (mm)	Ref.C
5.5	FEC4005T
7.0	FEC4007T



Flat Gold Cylinder

- Flat Cylinder Screw (FAS) included.
- Useful to make a customized abutment in difficult situations.
- Precious and non-precious alloys.
- Melting point of gold alloy : 1400 - 1450°C
- Threaded sleeves for convenient Resin / Wax-up.
- Recommend torque : 25Ncm

Profile Diameter	Ref.C
Ø3.8	FGC4012T

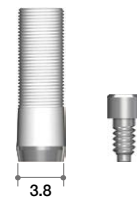

Flat CCM Cylinder

- Flat Cylinder Screw (FAS) included.
- Useful to make a customized abutment in difficult situations.
- Can be casted with non-precious alloys (Ni-Cr, Cr-Co alloys).
- Non-precious melting temperature : Depend on Manufacturer
- Threaded sleeves for convenient Resin / Wax-up.
- Melting temperature of CCM : 1300~1400°C
- Recommend torque : 25Ncm

Profile Diameter	Ref.C
Ø3.8	FCC4012T

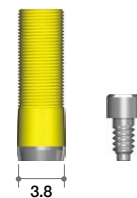

Flat Plastic Cylinder

- Flat Cylinder Screw (FAS) included.
- Recommend torque : 25Ncm

Profile Diameter	Ref.C
Ø4.0	FPC4012T

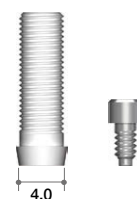

NEW PRODUCT

III. Overdenture Prosthesis

1. MegaGen Overdenture System

Meg-Loc

Compatible with products L and K, excellent functionality, & incomparable price!

Combination of Titanium housing and Pekkton (reinforced plastic) creates low water solubility and higher wear resistance and durability than other existing products.

Retention insert offers wide range of retention forces (600gf, 1200gf, 1800gf) to suit each patient, resulting in high level of satisfaction for both patient and dentist. Strong physical properties of Pekkton and insert gap increase elasticity, so that insert does not tear or break unlike conventional nylon products, thereby ensuring strong retention and longer life.

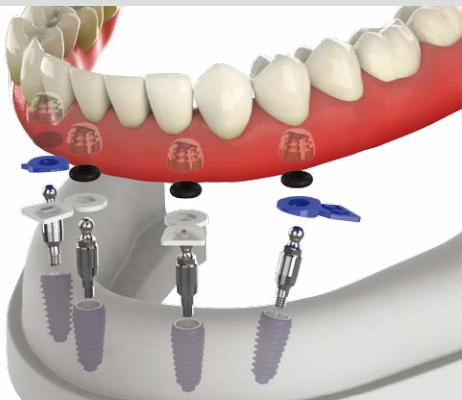

Meg-Ball

**Smallest housing, retentive ring with longer life!
Even when the implant angle is not parallel, a stable denture can still be produced!**

Compatible with other products with Ø2.25 head size, minimized patient inconvenience due to small-size housing, simpler to arrange artificial teeth as space occupied by denture is reduced, and easier to maintain than other systems.

Retentive ring has a high elasticity, abrasion resistance, and durability, thereby doubling the length of life when compared to a silicone O-ring and guaranteeing a longer life than NBR products.

Positioner (0/5/10/15 degrees) maintains parallel housing direction, even with distorted implant placement angle, ensuring denture stability.

Meg-Magnet

**Designed to maintain stable and sufficient magnetic force!
Completely blocks bursts and corrosion resistant!**

Structure is connected with abutment using magnetic force, which is feasible even with insufficient bone volume or poor bone quality. Easy to attach and detach, and minimal inflammation.

Magnet of Ø4.5 & Ø5.0 is compatible with other products, and laser marking on upper part makes it easy to distinguish between up and down.

Sufficient magnetic force (450gf, 650gf) ensures stable retention

Laser sealing blocks any bursting phenomenon.

TiN coating provides corrosion resistance.

Positioner (small & regular) prevents magnet from slipping in the mouth and stops any flow of impression materials under the abutment.

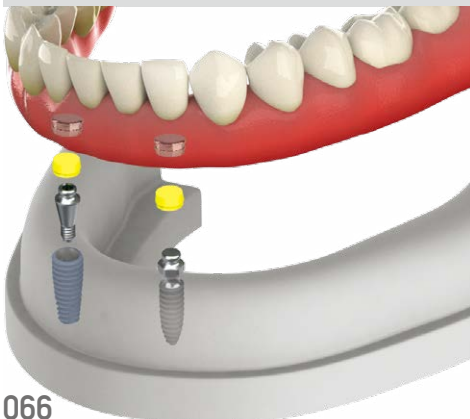
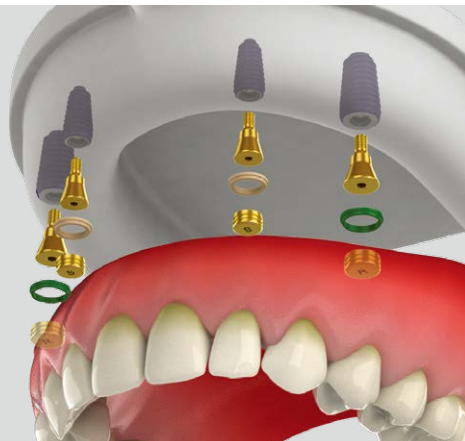

Meg-Rhein

Can compensate for tilted implant placement angle up to 50 °.

Combined head and housing structure is smallest on the market.

Retentive cap is based on Italian technology and has uniform physical properties. Various retention forces (600gf, 1200gf, 1800gf, 2700gf) classified by color can be selected according to each patient.

Dynamic housing with double structure enables tilting to 25 ° angle, allowing stable denture even when with distorted implant placement angle.

III. Overdenture Prosthesis

2. Meg-Loc Abutment & Component



Meg-Loc Metal Housing set



Block-out Spacer



Meg-Loc Abutment



►► Meg-Loc Overdenture System

Advantages

Easy compatibility

Compatible with Product L and Product K (same specifications)

Better abrasion resistance and durability

Combination of Titanium housing and reinforced plastic (Pekkton) provides low water solubility and high resistance, making it superior in abrasion resistance and durability compared to existing products.

Water Sorption Test

Property	Meg-Loc (Pekkton)	Product L	Unit
Water Sorption	8.7	93.5	µg/mm ³

Stronger retention and longer life

Strong physical properties of Pekkton and gap in insert increase the elasticity, preventing the insert from being torn or broken unlike existing nylon products, even when angle does not match when attaching & removing denture.

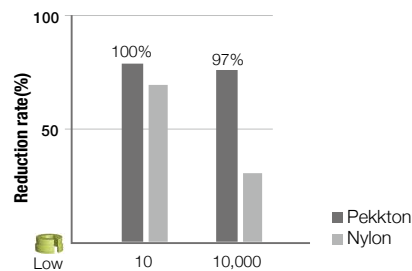

Easy to use

High resistance to plaque and easy cleaning
Easy replacement of retention insert

Tilting Angle



Various Retentive Caps of the Meg-Loc

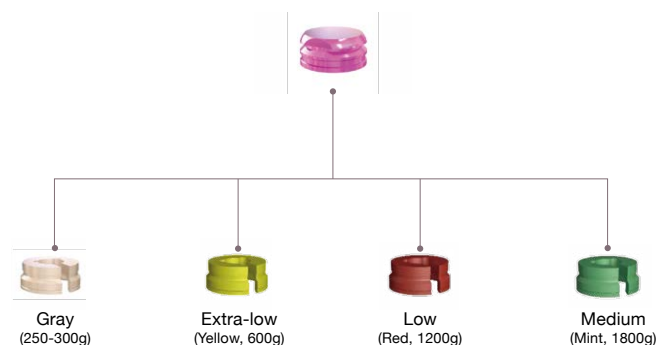

➔ Meg-Loc Overdenture System

Meg-Loc Abutment

- Angle compensation to one side 20 ° (both sides 40 °)
- Gently rounded shape
- Compatible with 1.2 Hex Driver
- **Recommend torque : 35Ncm**

Cuff Height (mm)	Ref.C
0	MLAR00
1.0	MLAR01
2.0	MLAR02
3.0	MLAR03
4.0	MLAR04
5.0	MLAR05
6.0	MLAR06



Meg-Loc Package

- 1 Meg-Loc Abutment

* Following package items are delivered with San DreMetto Korea packaging.

- 1 Titanium Housing
- 1 Block Out Spacer
- 4 Pekkton Retention Inserts (Gray-250~300gf(for lab), Yellow-600gf, Red-1200gf, Mint-1800gf)

Cuff Height (mm)	Ref.C
0	MLAR00P
1.0	MLAR01P
2.0	MLAR02P
3.0	MLAR03P
4.0	MLAR04P
5.0	MLAR05P
6.0	MLAR06P



Multi Tool

- Retention Insert Insertion & Removal Tool

Ref.C
MLMT



III. Overdenture Prosthesis

3. Meg-Ball Abutment & Component



►► Meg-Ball Overdenture System

<p>Advantages</p> <p>Easy compatibility</p> <p>Smallest Housing</p> <p>Double length of life</p> <p>Stable denture even when implant placement angle is distorted</p>	<div data-bbox="686 582 742 694"> <p>Ø2.25</p> </div> <p>Ø2.25 head size for easy compatibility with other products</p> <div data-bbox="678 772 750 862"> <p>Ø5</p> </div> <p>Metal Housing</p> <p>Small housing minimizes patient inconvenience, facilitates arrangement of artificial teeth by reducing space occupied by denture, and is easier to maintain than other systems.</p> <div data-bbox="686 1008 750 1052"> </div> <p>Retentive Ring</p> <p>High elasticity, abrasion resistance, and durability doubles the length of life when compared with silicone O-ring and guarantees longer life than NBR products.</p> <p>Positioner (0/5/10/15 degrees) maintains parallel housing direction even when angle of implant placement is distorted, ensuring denture stability</p> <div data-bbox="702 1321 1356 1500"> <p>0° 5° 10° 15°</p> </div>
<p>Tilting Angle</p>	<div data-bbox="845 1724 1197 2060"> <p>30°</p> </div>

➔ Meg-Ball Overdenture System

Meg-Ball Abutment

- Angle compensation to one side 15 °
(both sides 30 °)
- Ø2.25 Ball shape
- Recommend torque : 35Ncm

Cuff Height (mm)	Ref.C
0	MBAR00
1.0	MBAR10
2.0	MBAR20
3.0	MBAR30
4.0	MBAR40
5.0	MBAR50
6.0	MBAR60

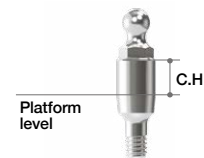

Meg-Ball Package

- Composed of Meg-Ball Abutment/
Metal Housing Set/
Housing Positioner (0°,5°,10°,15°)

Cuff Height (mm)	Ref.C
0	MBAR00P
1.0	MBAR10P
2.0	MBAR20P
3.0	MBAR30P
4.0	MBAR40P
5.0	MBAR50P
6.0	MBAR60P



Meg-Ball Metal Housing Set

- 1 Metal Housing
- 1 Retentive Ring

Ref.C
MBHR



Retentive Ring Set

Quantity	Ref.C
5	MBR5
10	MBR10



III. Overdenture Prosthesis

4. Meg-Magnet Abutment & Component

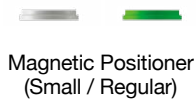

►► Meg-Magnet Overdenture System

Advantages

Easy to apply for elderly patients or disabled patients

Designed for maximum magnetic efficiency and durability

Outstanding retention
 - Blocks bursting
 - Corrosion resistant
 - Abrasion resistant

Easy to distinguish between up and down via laser marking on upper section

No slippage of magnet

Applicable with insufficient bone volume and poor bone quality
 Easy to attach and detach
 Unlikely to cause inflammation

Sufficient magnetic force (450gf, 650gf) to ensure stable retention
 Laser sealing blocks any bursting phenomenon

TiN coating provides corrosion resistance
 Over 0.1mm thickness at contact with attachment to ensure wear resistance



Magnet of Ø4.5 & Ø5.0 is compatible with other products
 Laser marking on upper part makes it easy to distinguish between up and down



Positioner (small & regular) prevents magnet from slipping in mouth and stops any flow of impression materials under the abutment

Small



Ø4.5
(450gf)

Regular



Ø5.0
(650gf)

Component of the Meg-Magnet

Ø4.5(Small)

450gf

Ø5.0(Regular)

650gf



➔ Meg-Magnet Overdenture System

Meg-Magnet Abutment

- Use to 1.2 Hex Driver
- Recommend torque : 35Ncm

Profile Diameter	Cuff Height (mm)	Ref.C
Ø4.5	0	MMAR400
	1.0	MMAR410
	2.0	MMAR420
	3.0	MMAR430
	4.0	MMAR440
	5.0	MMAR450
Ø5.0	0	MMAR500
	1.0	MMAR510
	2.0	MMAR520
	3.0	MMAR530
	4.0	MMAR540
	5.0	MMAR550

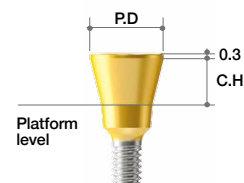

Meg-Magnet Package

- 1 Meg-Magnet Abutment
- 1 Magnet (Ø4.5-450gf, Ø5.0-650gf)
- 1 Magnetic Positioner

Profile Diameter	Cuff Height (mm)	Ref.C
Ø4.5	0	MMAR400P
	1.0	MMAR410P
	2.0	MMAR420P
	3.0	MMAR430P
	4.0	MMAR440P
	5.0	MMAR450P
Ø5.0	0	MMAR500P
	1.0	MMAR510P
	2.0	MMAR520P
	3.0	MMAR530P
	4.0	MMAR540P
	5.0	MMAR550P



Meg-Magnet Attachment Set

Size	Ref.C
Small	MA402
Regular	MA502

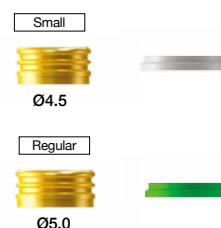

III. Overdenture Prosthesis

5. Meg-Rhein Abutment & Components

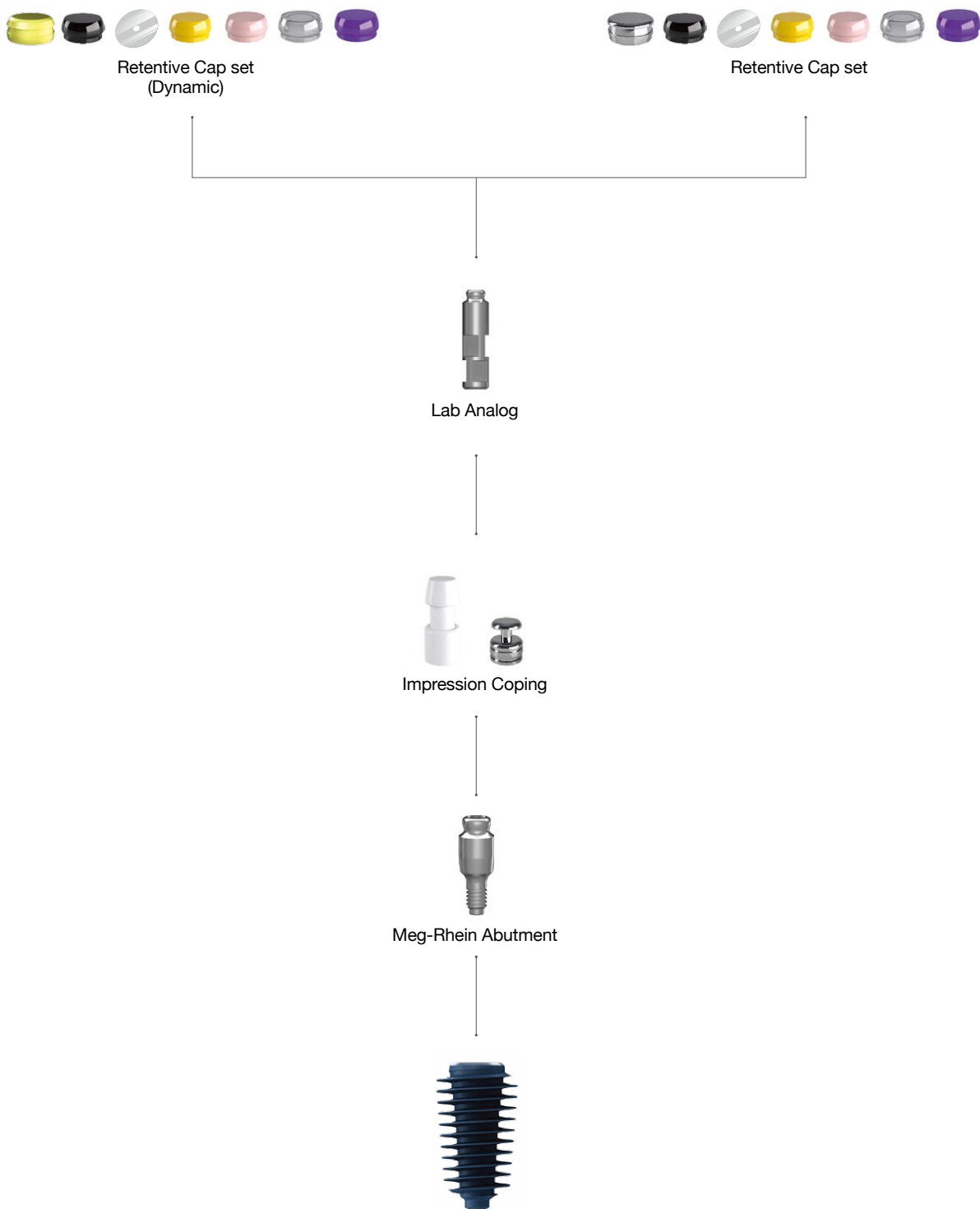

➔ Meg-Rhein Overdenture System

Meg-Rhein Overdenture System (Dynamic)

- 1 Meg-Rhein Abutment
- 1 Plastic Impression Coping
- 1 Stainless Steel Housing (Dynamic) & Black-Lab
- 1 Protective Disk
- 4 Retentive Caps
(Yellow-0.6kgf, Pink-1.2kgf, White-1.8kgf, Violet-2.7kgf)

- Perfect compatibility with the Rhein83 from Italy.
- Recommend torque : 15Ncm.

Cuff Height (mm)	Ref.C
0	ADR00PA
1.0	ADR01PA
2.0	ADR02PA
3.0	ADR03PA
4.0	ADR04PA
5.0	ADR05PA
6.0	ADR06PA

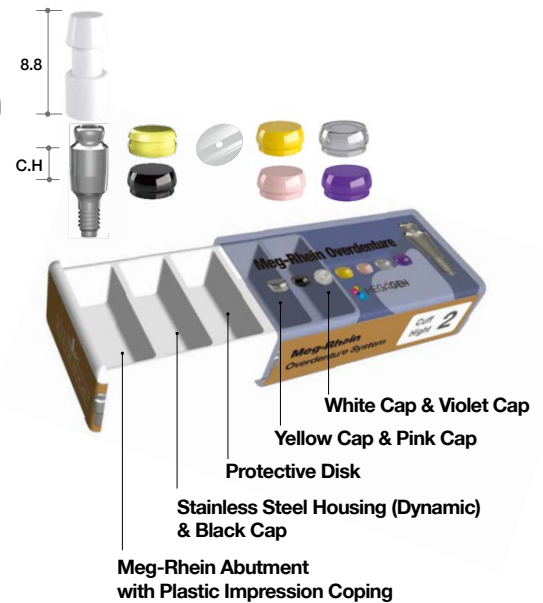

Meg-Rhein Overdenture System

- 1 Meg-Rhein Abutment
- 1 Plastic Impression Coping
- 1 Stainless Steel Housing
- 1 Protective Disk
- 5 Retentive Caps
(Black-Lab, Yellow-0.6kgf, Pink-1.2kgf, White-1.8kgf, Violet-2.7kgf)

- Perfect compatibility with the Rhein83 from Italy.
- Recommend torque : 15Ncm.

Cuff Height (mm)	Ref.C
0	ADR00P
1.0	ADR01P
2.0	ADR02P
3.0	ADR03P
4.0	ADR04P
5.0	ADR05P
6.0	ADR06P



►► Overdenture System

Advantages

Small & Easy-to-Use Housing System 

Tilting Angle

Various Retentive Caps of the Meg-Rhein

Low Reduction Rate & Uniform Variance of Retentive Force

Normal



Dynamic

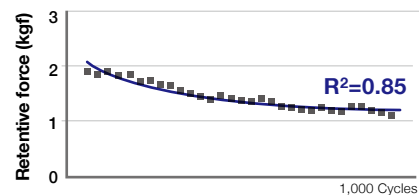
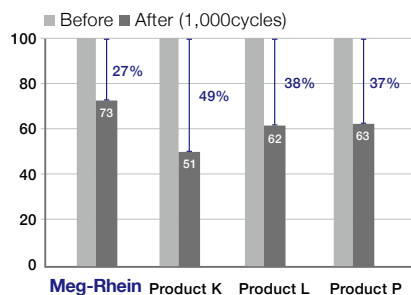
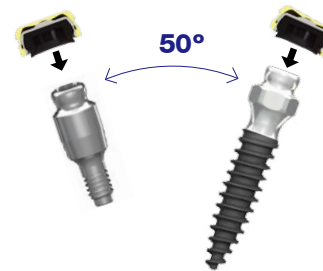
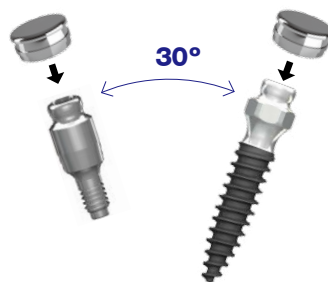
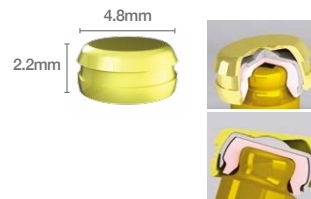

R^2 (Coefficient of determination) becomes more reliable when it is close to "1".

➔ Components for Meg-Rhein Abutment (Continued)

Stainless Steel Housing

- 5ea/pack

Ref.C

MHP



Stainless Steel Housing

(Dynamic)

- 5ea/pack

Ref.C

THP



Retentive Caps (White)

- White cap(1.8kg) - For refill (5ea/pack).
- Can be used for more retentive force following pink cap(1.2kgf).

Ref.C

RCWP



Retentive Caps (Violet)

- Violet cap(2.7kg) - For refill (5ea/pack).
- Can be used for more retentive force following white cap(1.8kgf).

Ref.C

RCVP



Retentive Caps (Pink)

- Pink cap(1.2kgf) - For refill (5ea/pack).

Ref.C

RCPP



➔ Components for Meg-Rhein Abutment

Retentive Caps (Yellow)

- Yellow cap(0.6kgf) - For refill (5ea/pack).

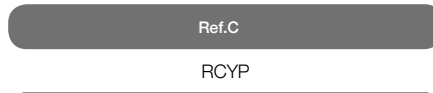

Retentive Caps (Black)

- For laboratory

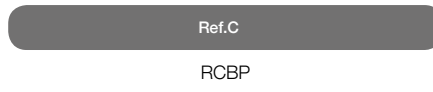

Stainless Impression Coping (Pick-Up)

- 2ea/pack.
- Italy - Rhein 83 products.
- For accurate (pick-up type) impression.
- Metal with groove design to prevent from swaying.



Lab Analog

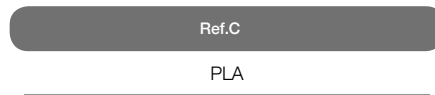

Retentive Cap Removal Tool

- Retentive Cap removal tool.

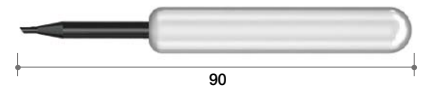
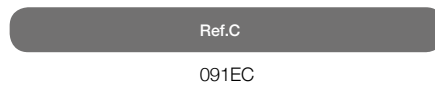

Retentive Cap Insertion Tool

- Retentive Cap insertion tool.

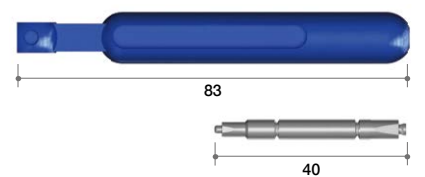
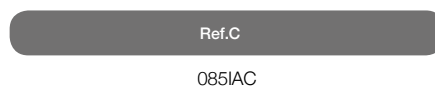

AnyRidge Kit

I. AnyRidge Abutment Selection Guide Kit

Ref.C
KANASG3000

For the best selection of abutments.

- Colors indicate different cuff heights (Yellow : 2mm, White : 3mm, Pink : 4mm, Red : 5mm).
- Store 2 pieces in each container.
- Autoclavable to sterilize.

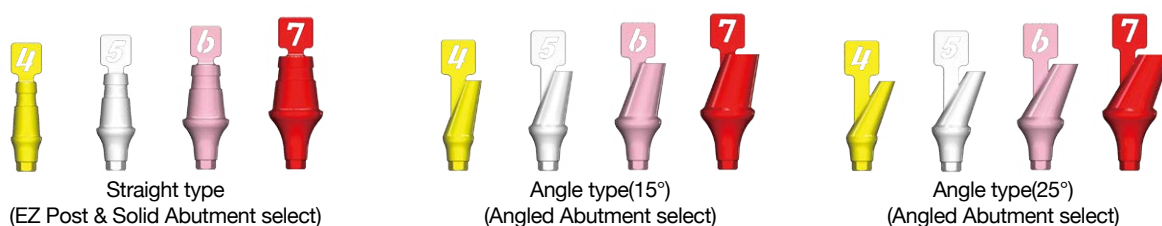
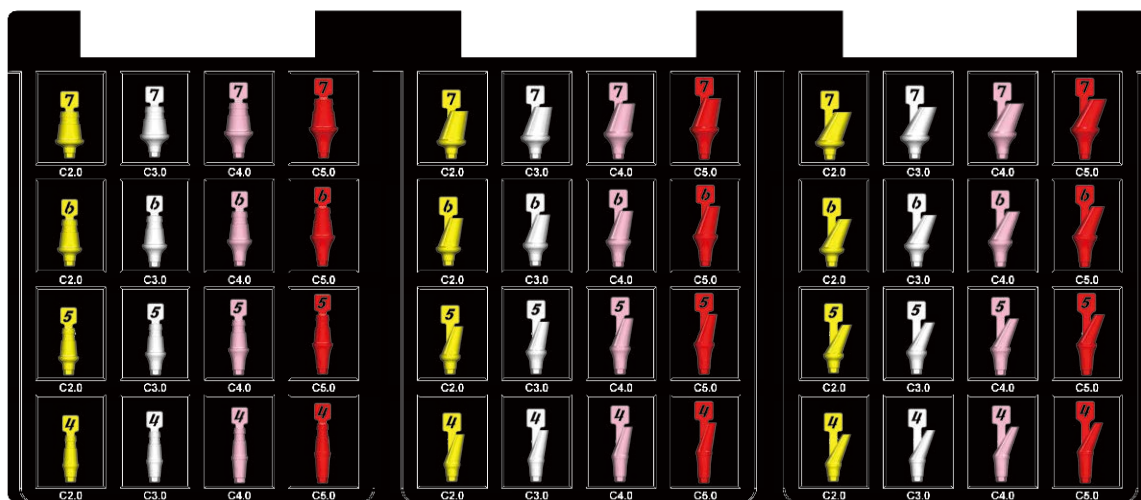

II. AnyRidge Surgical Kit : Standard Type

Ref.C
KARIN3003

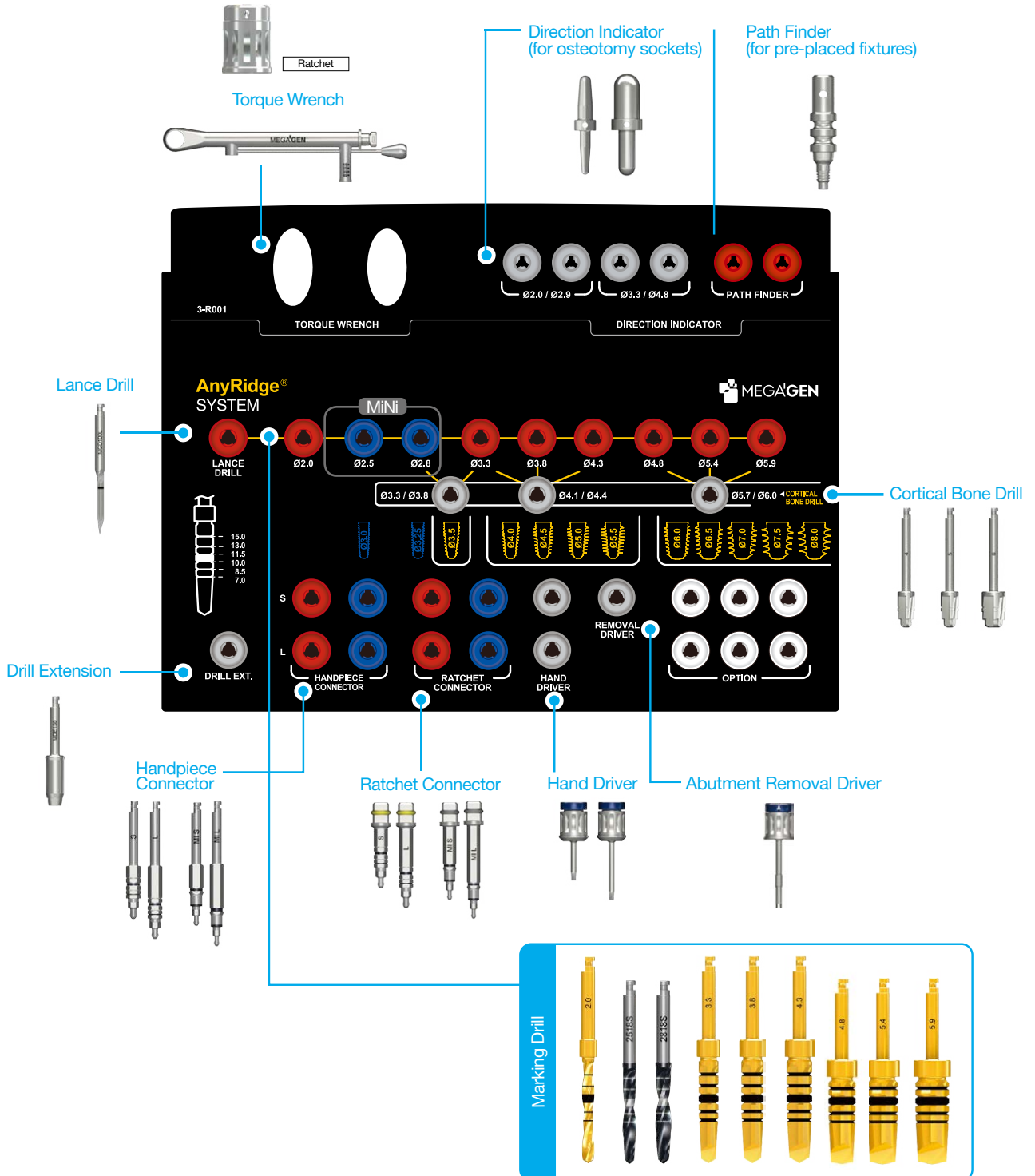

II. AnyRidge Surgical Kit : Full Type

Ref.C
KARIN3001

Easier and safer to drill for the depth as you need with the stopper drills.

AnyRidge SYSTEM

STOPPER DRILL

MARKING DRILL

Labels and Components:

- Torque Wrench
- Ratchet
- Direction Indicator (for osteotomy sockets)
- Path Finder (for pre-placed fixtures)
- Lance Drill
- Cortical Bone Drill
- Handpiece Connector
- Ratchet Connector
- Hand Driver
- Abutment Removal Driver
- Drill Extension
- Point Trephine Bur
- Trephine Bur

Stopper Drill Part Numbers: 2007, 2008, 2010, 2011, 28107M, 28108M, 28109M, 28110M, 3307, 3308, 3310, 3311, 4007, 4008, 4009, 4011

Marking Drill Part Numbers: 2.0, 2518S, 2518S, 3.3, 3.8, 4.3, 4.8, 5.4, 5.9

➔ Surgical Kit Components

Lance Drill

- Useful to make an indentation on cortical bone to confirm the exact drilling location.

Diameter	Type	Ref.C
Ø2.0	Long	MGD100L

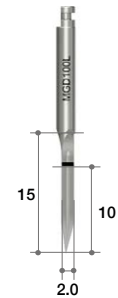

Marking Drill

- Each drill has calibrations from 7.0 to 18.0mm. (TANSDF4815, TANSDF5415, TANSDF5915 have calibrations up to 15.0mm)
- Easy to recognize by dual marking systems. (Groove and laser marking)

Diameter	Length (mm)	Ref.C
Ø2.0	18	TANTDF2018
Ø2.5		SD2518S
Ø2.8		SD2818S
Ø3.3		TANSDF3318
Ø3.8		TANSDF3818
Ø4.3		TANSDF4318
Ø4.8	15	TANSDF4815
Ø5.4		TANSDF5415
Ø5.9		TANSDF5915



Stopper Drill

Diameter	Length (mm)	Ref.C
Ø2.0	7	TANTDF2007
	8.5	TANTDF2008
	10	TANTDF2010
	11.5	TANTDF2011
Ø2.8	7	SD2807M
	8.5	SD2808M
	10	SD2810M
	11.5	SD2811M
Ø3.3	7	TANSDF3307
	8.5	TANSDF3308
	10	TANSDF3310
	11.5	TANSDF3311
Ø3.8	7	TANSDF3807
	8.5	TANSDF3808
	10	TANSDF3810
	11.5	TANSDF3811
Ø4.3	7	TANSDF4307
	8.5	TANSDF4308
	10	TANSDF4310
	11.5	TANSDF4311
Ø4.8	7	TANSDF4807
	8.5	TANSDF4808
	10	TANSDF4810
	11.5	TANSDF4811

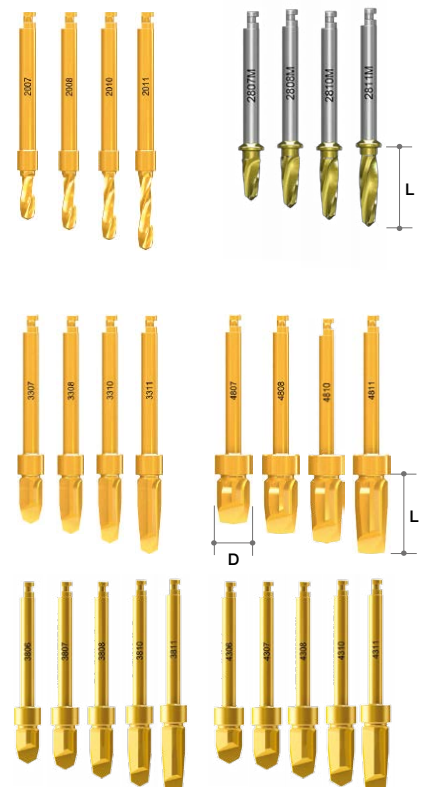

➔ Surgical Kit Components (Continued)

Point Trephine Bur

Diameter	Ref.C
Ø5.0 (In.Ø4.0)	SPTB4050



Trephine Bur

- Minimizes the drilling steps needed, especially for wider fixtures.
- Helpful for collecting autogenous bone.
- Useful for removing failed and fractured fixtures.
- Depth markings are 7, 8.5, 10, 11.5, 13mm, same depths as fixtures. (No Y dimension so markings are actual length).
- Markings on the drill shaft represent the inside / outside diameter of Trephine Burs.

Diameter	Type	Ref.C
Ø3.5 (in Ø2.5)	Short (32mm)	TANTBL2535
Ø5.0 (in Ø4.0)		TANTBL4050
Ø6.0 (in Ø5.0)		*TANTBL5060
Ø7.0 (in Ø6.0)		*TANTBL6070
Ø3.5 (in Ø2.5)	Long (38mm)	*TANTBE2535
Ø5.0 (in Ø4.0)		*TANTBE4050
Ø6.0 (in Ø5.0)		*TANTBE5060
Ø7.0 (in Ø6.0)		*TANTBE6070

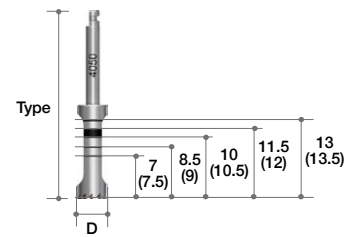

(*) Separate sales item.

3.5, 5.0 Trephine Bur are included in Surgical kit.

Cortical Bone Drill

- Removes cortical bone and enlarges osteotomy socket especially at hard bone.
- Similar function with countersink drill of other systems.
- Each drill has two steps of diameter for convenience.

Diameter	Ref.C
Ø3.5	TANCDL3500
Ø4.0~ Ø5.5	TANCDL4055
Ø6.0~ Ø8.0	TANCDL6080

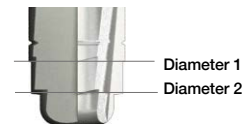

Handpiece Connector

- Delivers torque for the placement of a fixture with a handpiece.
- Easy and secure pick-up and delivery.
- Used to place an implant without a mount.
- Marks on the shaft can indicate the position of fixture platform, especially in flapless surgery.

Length (mm)	Type	Ref.C
5	*Ultra short	TANHCU
10	Short	TANHCS
15	Long	TANHCL
10	Short (MiNi)	HCS17
15	Long (MiNi)	HCL17

(*) Separate sales item.

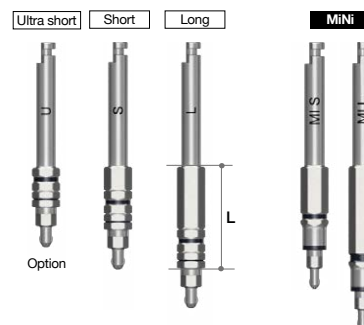

Ratchet Connector

- Delivers torque for the placement or removal of a fixture with a Ratchet Wrench.
- Secure a Ratchet Extension or Torque Wrench to a fixture before exerting force.
- Too much torque force can result a damage to the hex of a fixture.
- Marks on the shaft can indicate the position of fixture platform, especially for flapless surgery.

Length (mm)	Type	Ref.C
6	*Ultra short	TANREU
10	Short	TANRES
15	Long	TANREL
15	Short(MiNi)	RCS17
20	Long (MiNi)	RCL17

(*) Separate sales item.

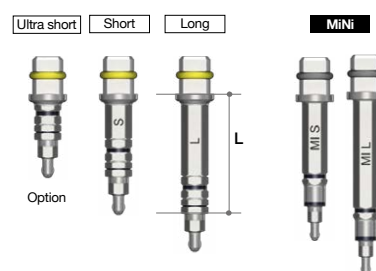

Hand Driver (1.2 Hex)

- Used for all Cover Screws, all Abutment Screws and all Healing Abutments.
- Available in 4 lengths for convenience.
- Hand Driver can be directly inserted into the Torque Wrench without using an adapter.
- Hex tip can withstand 35-45Ncm of torque without distortion.

Length(mm)	Type	Ref.C
5	*Ultra-short	TCMHDU1200
10	Short	TCMHDS1200
15	Long	TCMHDL1200
20	*Extra-long	TCMHDE1200

(*) Separate sales item.

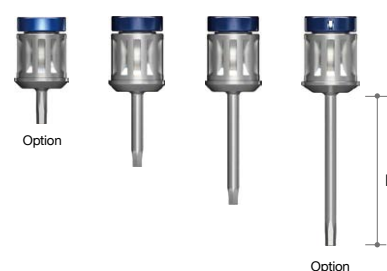

➔ Surgical Kit Components

Abutment Removal Driver

- Used to remove final abutment ; use after removing Abutment Screw.
- Insert straight into the abutment and rotate clockwise.
- Long Abutment Removal Driver is for disconnecting an abutment with a cemented crown.

Length (mm)	Ref.C
17.5	TANMRD18
25.0	*TANMRD25

(*) Separate sales item.



Drill Extension

- Extends drills & other handpiece tools.
- No more than 35Ncm torque : Can be distorted when too much force is applied.

Ref.C
MDE150



Direction Indicator

- Confirms drilling direction and location during drilling.
- Checks drilling position.

Length (mm)	Ref.C
Ø2.0 / Ø2.8	MDI100
Ø3.2 / Ø4.7	MDI3348

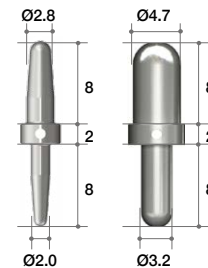

Path Finder

- After placing a fixture, a Path Finder can be connected to guide parallel for the next implant.
- Gingival depth can be measured with the grooves especially for flapless surgeries.

Length (mm)	Ref.C
10	TANPF3580

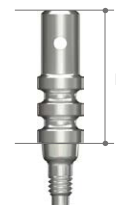

Torque Wrench & Adapter

- Torque Wrench has torque options from 15Ncm to 45Ncm and is used for the placement of an implant and final tightening of the Abutment Screw.

Type	Ref.C
Torque Wrench	MTW300AT
*Torque Wrench Adapter(Handpiece)	TTAI100
Torque Wrench Adapter(Ratchet)	TTAR100

(*) Separate sales item.

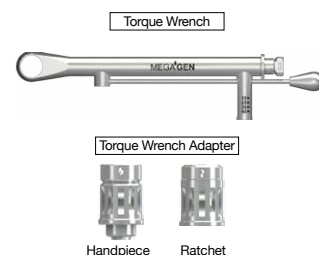

III. AnyRidge Prosthetic Kit

Ref.C
KANPK3000

A kit with all kinds of driver that are needed for prosthetics.

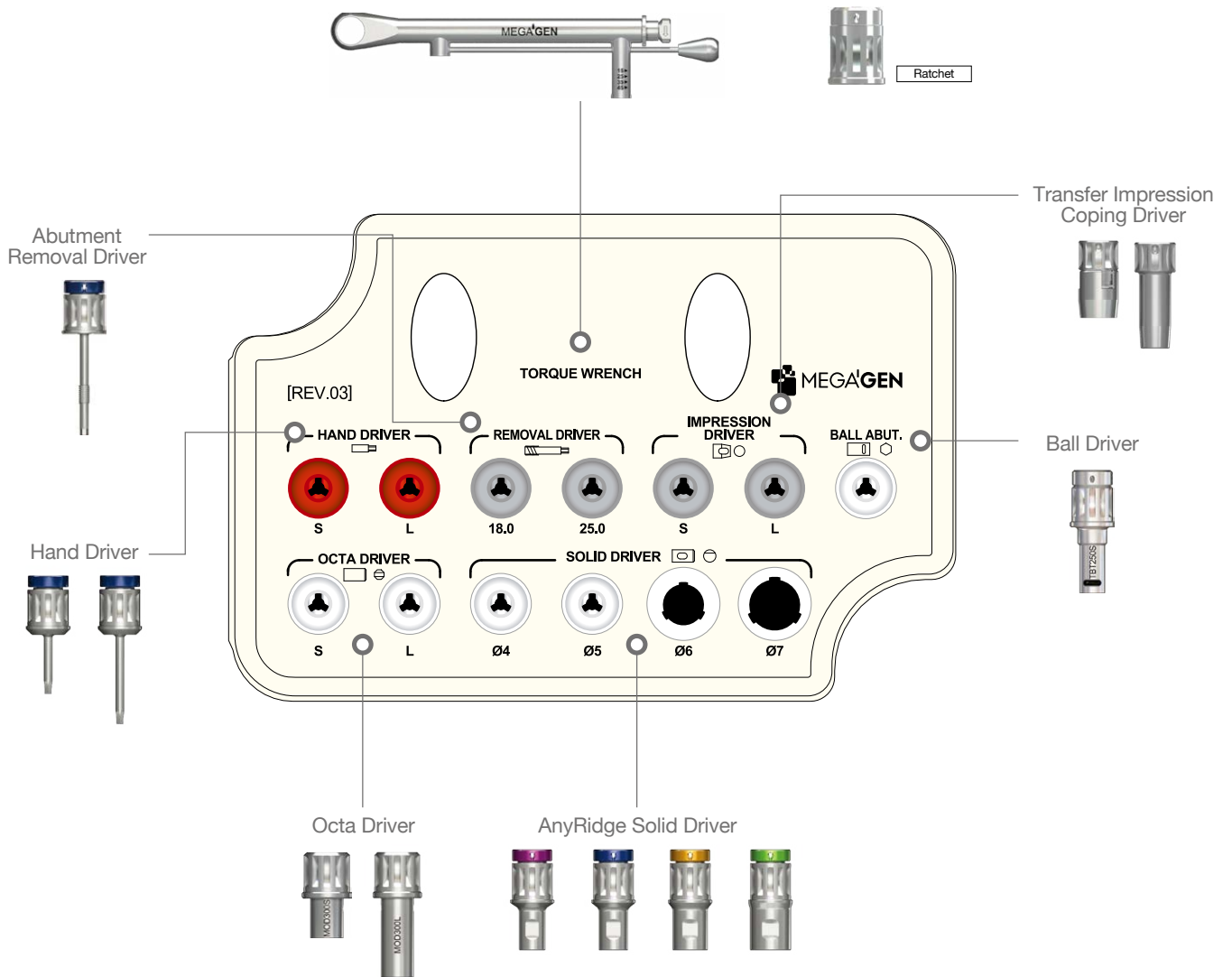

➔ Prosthetic Kit Components

Solid Driver

- For the delivery of Solid Abutments.
- Color coded for different profile diameters. (Ø4-magenta, Ø5-blue, Ø6-yellow, Ø7-green)
- Two different heights. (8.5 / 13.5mm)
- Directly connectable to Torque Wrench.

Solid Abutment Profile Diameter	Length(mm)	Ref.C
Ø4	8.5	TANSDS400
	13.5	*TANSDL400
Ø5	8.5	TANSDS500
	13.5	*TANSDL500
Ø6	8.5	TANSDS600
	13.5	*TANSDL600
Ø7	8.5	TANSDS700
	13.5	*TANSDL700



(*) Separate sales item.

Octa Driver

- For seating of the Octa Abutment into the fixture.
- Can also be connected to Torque Wrench.

Length (mm)	Ref.C
7	MOD300S
13	MOD300L



Ball Driver

- For seating of the Ball Abutment into the fixture.
- Can connect to a Handpiece, Ratchet or Torque Wrench.
- Available in long and short.

Type	Ref.c
*Handpiece Connector(Short)	TBH250S
*Handpiece Connector(Long)	TBH250L
*Ratchet Connector(Short)	TBR250S
*Ratchet Connector(Long)	TBR250L
Toque Driver(Short)	TBT250S
*Toque Driver(Long)	TBT250L

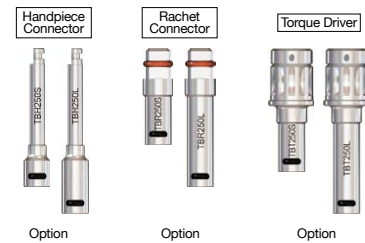

(*) Separate sales item.

Impression Coping Driver (Transfer)

- For transfer type of Impression Coping.
- Works with friction only.
- Small but powerful grip.

Type	Ref.C
For Two piece impression Coping	TCMID
For One piece impression Coping	TCMIDE

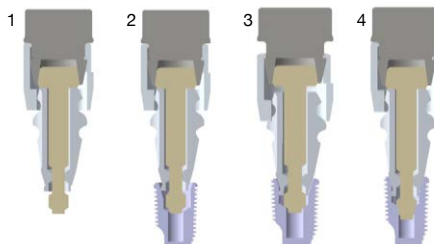

1. Connect Impression Coping and Impression Driver together
2. Adjust Connection with a Fixture by turning a Holder clockwise.
3. Push the Holder and put the Impression Coping into the Fixture.
4. Turn the Driver clockwise to ensure connection of the Impression Coping and Fixture.

IV. AnyRidge Bone Profiler Kit

Ref.C

KARBP3000

Removes the overhanged bone around a fixture to allow adequate seating of a Healing Abutment or a Prosthetic Abutment.

- Place a Guide Pin into a fixture and choose a Bone Profiler which fits with the situation.
- Four different sizes of bone profiler and four guide pins are included in the kit.

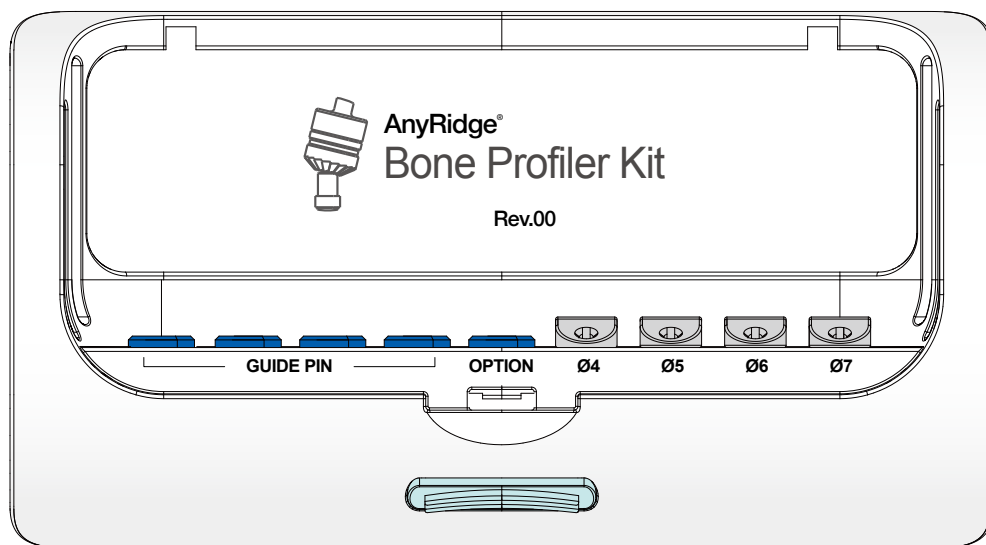

Bone Profiler

- Guide Pin(TANPGF3305) included.

- Each bone profiler can be purchased separately for refill.
- Each package includes a bone profiler and a guide pin.

Profile Diameter	Length (mm)	Ref.C
Ø4	13	TANBPL40G
Ø5		TANBPL50G
Ø6	8	TANBPS60G
Ø7		TANBPS70G



V. Optional components

- not included in the surgical kit
- can be purchased separately and placed into the 'option' spaces provided in the surgical kit

Right Angle Driver Tip

- Used for all Cover Screws, all abutment screws and all Healing Abutments.
- Hex tip can withstand 35-45Ncm of torque without distorting.

Length(mm)	Type	Ref.C	
4	Ultra-short	Hex 1.2	MDR120SS
10	Short		MDR120S
15	Long		MDR120L
20	Extra Long		MDR120EL



Lindermann Drill

- Cross cut on the drill.
- Can correct the path during drilling.

Diameter(mm)	Ref.C
2	TEEL200M

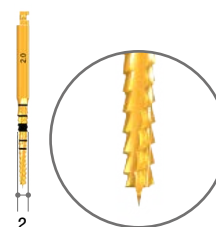

Insert Driver

- Used for all Cover Screws, all abutment screws and all Healing Abutments.
- Hex tip can withstand 35-45Ncm of torque without distorting.

Length(mm)	Type	Ref.C	
10	Short	Hex 1.2	MID120S
15	Long		MID120L



Hand Tap

- Useful when the internal screw of a fixture is damaged.
- Retapping damaged threads.
- Need to be patient and force-controlled.

Type	Ref.C
M1.8	THT180L



Multi-unit Driver (2.0 Hex) (For Multi-unit Abutment)

- For the seating & tightening of multi-unit Abutment (Straight type)

Length(mm)	Type	Ref.C
10	Short	TCMMUDS20
15	Long	TCMMUDL20



Flattening Drill

- In the case of irregular bone, stopper drill can be drilled in precise depth by flattening the bone.
- Flattening Lance and Housing are connected together. Two types of Housing diameters (Ø5.0 & Ø6.0) are composed in accordance with the size of final drill diameter.
- Ø5.0 = Stopper Drill Ø2.0~ Ø4.3
- Ø6.0 = Stopper Drill Ø4.8~ Ø5.4
- Formation of boundary through housing will guide the next drilling location of fixture.

Diameter	Length (mm)	Ref.C
Ø5.0 / Ø2.0	3.5	FD5020
Ø6.0 / Ø2.0		FD6020

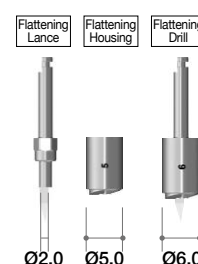

Manual Inserter

- Specially designed for manual placement of AnyRidge fixture.
- Especially useful at immediate implant placement on maxillary anterior.
- The tip has same structure with the hand-piece connector.

Ref.C
TANMI



Reamer Drill & Center Pin

- Removes inner lip of the cast after casting Burn-out Cylinders of Solid Abutment.
- Center Pin have 4 different diameters according to the profile diameter of Solid Abutments.

Diameter	Type	Ref.C
Ø10.0	Reamer Drill	TANRD
Ø4.0	Center Pin	TANRDJ40
Ø5.0		TANRDJ50
Ø6.0		TANRDJ60
Ø7.0		TANRDJ70



Trephine Bur Stopper

- Controls the depth of trephination with a Stopper placed into the Trephine.
- Especially useful in cases with limited available bone from important anatomy.

Length (mm)	Ref.C
7.0	TANTSF2307
8.5	TANTSF2308
10.0	TANTSF2310
11.5	TANTSF2311

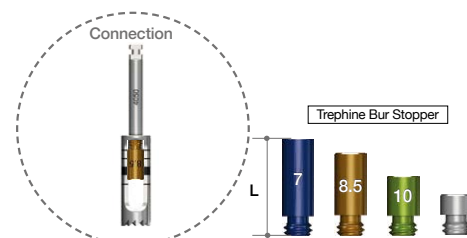

Bottom Drill

- It removes remaining bone in osteotomy socket after trephine drilling.
- It imprints the sizes of fixtures, for example 7, 8.5, 10, 11.5 and 13mm, by laser marker.

Diameter	Type	Ref.C
Ø3.3	Short (32mm)	TCMBDS33
Ø3.8		TCMBDS38
Ø4.8		TCMBDS48
Ø5.8		TCMBDS58
Ø6.8		TCMBDS68
Ø3.3	Long (38mm)	TCMBDL33
Ø3.8		TCMBDL38
Ø4.8		TCMBDL48
Ø5.8		TCMBDL58
Ø6.8		TCMBDL68

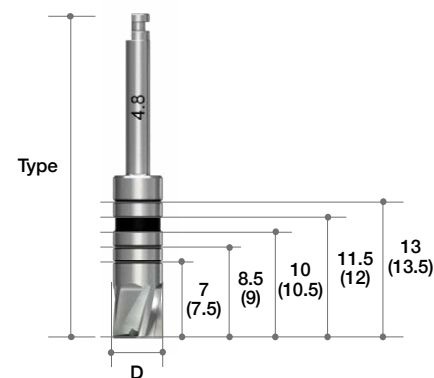

Ratchet Wrench

- Used to exert more force than handpiece.
- No bearing system : No breakage and corrosion problems.
- Attaches to Ratchet Extension.
- Arrow laser marking indicates direction of force.

Ref.C
MRW040S



R2GATE Full Surgical KIT

I. R2GATE Full Surgical Kit for AnyRidge System

- If you only use a specific system, corresponding system's full kit can be provided.
- R2GATE full surgical kit is composed with all of drills and components that are needed for the Digital Guided Surgery which uses R2GATE Guide™ after R2GATE™ diagnosis. It helps to actualize minimally invasive surgery and makes exact clinical result as the diagnosis.

Ref.C
KAGIN3000



Cortical Bone Drill

In type I or II bone, crestal bone is partly reduced to lower the pressure against the fixture during placement.

Initial Drill

Initial Drill Second Drill

Drilling to make the initial drill path

AnyRidge ANYGUIDE R2

CORTICAL DRILL

INITIAL DRILL

SECOND DRILL

DRILL EXTENSION

Guide Stop Drill

Drill diameter : Ø2.0 ~ Ø5.9
Drill Length : 7.0 ~ 13.0mm

Guide length : 13.5mm
Drilling length : 7.0 ~ 13.0mm

Drill Extension

Bone Profiler



This is used to minimize the interference of the crestal bone when connecting ZrGEN Abutment, [Used before placing the fixture / Recommended RPM 600 ~1000]

Implant Carrier

: Handpiece type
: Ratchet type

- ▶ R – AnyRidge Regular (ø3.5 ~ø4.5)

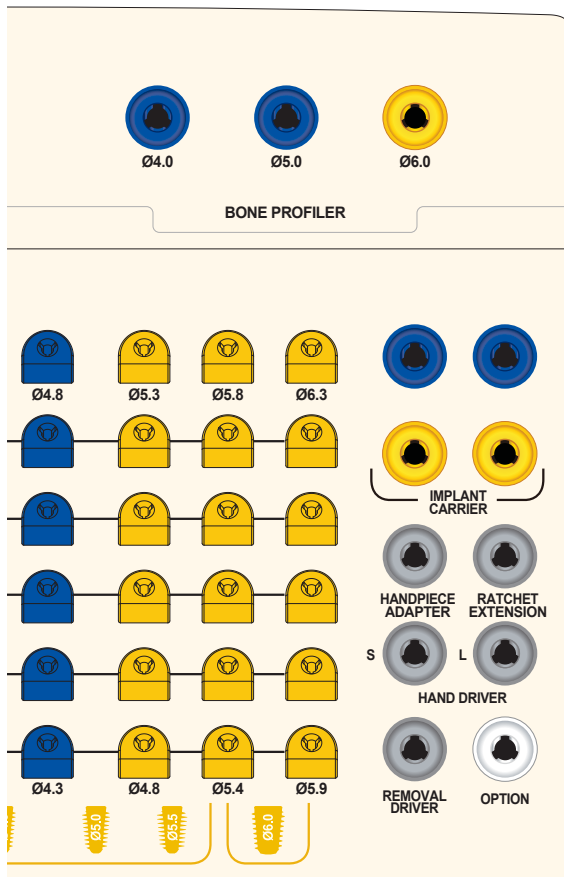

- ▶ W – AnyRidge Wide (ø5.0 ~ ø6.0)

BONE PROFILER

Ø4.0 Ø5.0 Ø6.0

IMPLANT CARRIER

Ø4.8 Ø5.3 Ø5.8 Ø6.3

HANDPIECE ADAPTER **RATCHET EXTENSION**

HAND DRIVER

S L

REMOVAL DRIVER **OPTION**

Ø4.3 Ø4.8 Ø5.4 Ø5.9

Ø4.0 Ø5.0 Ø6.0



Hand Driver

- : 1.2 hex driver (Short)
- : 1.2 hex driver (Long)
- : Abutment Remover Driver



Carrier-Handpiece Adapter



Carrier Extension



➔ Components for R2GATE Full Surgical Kit (Continued)

- If you only use a specific system, corresponding system's full kit can be provided.
- R2GATE full surgical kit is composed with all of drills and components that are needed for the Digital Guided Surgery which uses R2GATE Guide™ after R2GATE™ diagnosis. It helps to actualize minimally invasive surgery and makes exact clinical result as the diagnosis.

Initial Drill

- Use the initial drill in order to mark the drilling position on the bone. Start drilling slowly, when drill guide part is fully contacted with drilling core of R2GATE Guide™.
- Recommended drilling speed range is 300 ~ 800 RPM with copious irrigation.

Diameter	Guide Diameter	Length(mm)	Ref.C
Ø2.6	Ø5.0	1.0	R2ID2601

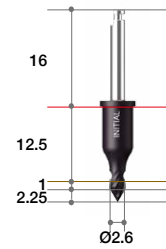

Second Drill

- This unique step-drill(from Ø2.0 to Ø4.6) is used to flare out the upper cortical bone of the osteotomy.
- It helps not only the rest drilling procedure but abut- ment connection. In case of hard bone, if the 2nd drilling will be disturbed by thick cortical bone. Stop the drilling and try it after final drilling procedure.

Diameter	Guide Diameter	Length(mm)	Ref.C
Ø2.5	Ø5.0	5.0	R2SD2505



Stopper Drill

- Universal drills consist of Ø2.0, Ø2.5, Ø2.8 diameter to enlarge the osteotomy gradually.
- The length of drill are designed as 7.0, 8.5, 10, 11.5, 13mm for most common length of implant system.
- Recommended drilling speed range is 500 ~ 800 RPM with copious irrigation.

Diameter	Guide Diameter	Length(mm)	Ref.C
Ø2.0	Ø5.0	6.5	AGSD2007
		8.0	AGSD2008
		9.5	AGSD2010
		11.0	AGSD2011
		12.5	AGSD2013
Ø2.5		6.5	AGSD2507
		8.0	AGSD2508
		9.5	AGSD2510
		11.0	AGSD2511
		12.5	AGSD2513
Ø2.8		6.5	AGSD2807
		8.0	AGSD2808
		9.5	AGSD2810
		11.0	AGSD2811
		12.5	AGSD2813

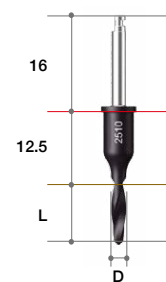

Bone Profiler

- Recommended drilling speed is 300 ~ 800 RPM.

Diameter	Guide Diameter	Ref.C
Ø4.0	Ø5.0	AGBP40
Ø5.0		AGBP50
Ø6.0		AGBP60



Stopper Drill

• Recommended drilling speed is 300 ~ 800 RPM.

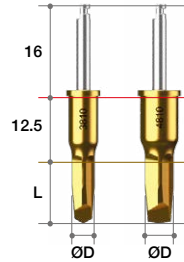

Diameter	Guide Diameter	Length(mm)	Ref.C	Diameter	Guide Diameter	Length(mm)	Ref.C
Ø3.3	Ø5.0	6.5	ARSD3307	Ø4.8	Ø6.5	6.5	ARSD4807
		8.0	ARSD3308			8.0	ARSD4808
		9.5	ARSD3310			9.5	ARSD4810
		11.0	ARSD3311			11.0	ARSD4811
		12.5	ARSD3313			12.5	ARSD4813
Ø3.8	Ø5.0	6.5	ARSD3807	Ø5.4	Ø6.5	6.5	ARSD5407
		8.0	ARSD3808			8.0	ARSD5408
		9.5	ARSD3810			9.5	ARSD5410
		11.0	ARSD3811			11.0	ARSD5411
		12.5	ARSD3813			12.5	ARSD5413
Ø4.3	Ø5.0	6.5	ARSD4307	Ø5.9	Ø6.5	6.5	ARSD5908
		8.0	ARSD4308			8.0	ARSD5907
		9.5	ARSD4310			9.5	ARSD5910
		11.0	ARSD4311			11.0	ARSD5911
		12.5	ARSD4313			12.5	ARSD5913

Cortical Bone Drill

• Recommended drilling speed : 300 ~ 800 RPM

Diameter	Guide Diameter	Length(mm)	Ref.C
Ø3.4	Ø5.0	5.0	R2CD3405
Ø3.8			R2CD3805
Ø4.3			R2CD4305
Ø4.8			R2CD4805
Ø5.3	Ø6.5	5.0	R2CD5305
Ø5.8			R2CD5805
Ø6.3			R2CD6305

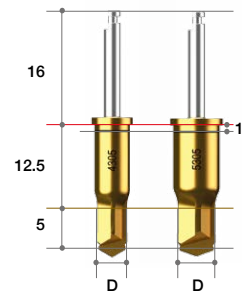

➔ Components for R2GATE Full Surgical Kit

Implant Carrier

- The purpose of tab drills in the universal kit system is insertion test. some of implant are required this procedure before final fixture insertion. choose the one-step under size of tab to protect from enlargement of osteotomy.
- Recommended insertion torque and speed is 45 ~ 50Ncm, under 40 RPM.

Connection	Guide Diameter	Type	Ref.C
2.3 Hex	Ø5.0	Ratchet	ICRH2324
	Ø6.5		ICWH2324
	Ø5.0	Handpiece	ICRH2324H
	Ø6.5		ICWH2324H

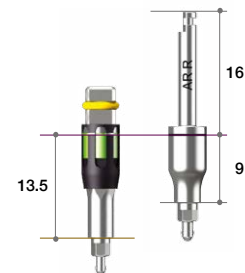

Carrier-Handpiece Adapter

- Useful to use the handpiece for the implant placement following initial delivery of a fixture with a fixture carrier.

Diameter	Ref.C
5.0	AGHA



Carrier Extension

- To extend the length of implant carrier.

Diameter	Ref.C
4.0	MRE400S



Drill Extension

- No more than 35Ncm torque : May distorted when excessive force is applied.
- Extends drills & other handpiece instruments.

Ref.C
MDE150



Hand Driver (1.2 Hex)

- Used for all Cover Screws, Abutment Screws, and Healing Abutments.
- Available in 4 lengths for added convenience.
- Hand Driver can be directly inserted into the Torque Wrench without using an adaptor.
- Hex tip can with stand 35-45Ncm of torque without distorting.

Length(mm)	Type	Ref.C
5.0	*Ultra-short	TCMHDU1200
10	Short	TCMHDS1200
15	Long	TCMHDL1200
20	*Extra-long	TCMHDE1200

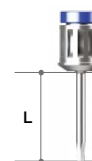

(* Separate sales item.

Ratchet Wrench

- Used to exert more force than the Handpiece.
- No bearing system : No breakage and no corrosion problems.
- Arrow laser marking indicates direction of force.

Ref.C
MRW040S



R2GATE Universal Kit

Maximize the cost-effectiveness & efficiency.

Ref.C
KAGUN3000

When you want to do R2GATE surgery with R2GATE Guide™, Please inform us your favorite implant system

Make your own R2GATE Surgical Kit with your favorite implant system. R2GATE Universal kit consists of basic drilling set which can be used for any implant system. You can add system options as “Implant Carrier”, “Cortical Bone Drill”, “Tap Drill” to your favorite implant system. The specification of final drills will be decided with treatment planning and delivered to you with R2GATE Guide™ will be from the R2GATE Design Center.

Universal Kit
Consisted of basic drilling set which can be used for any implant system

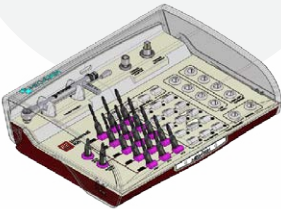

Customized instrument for various implant system

AryRidge / AryRidge Octa 1 / AnyOne Mini / ST BoneLevel(Straumann) / Nobel Active(Nobel Biocare) / SuperLine(Dentium) / TSIII(Osstem)
(Available system can be varied by country due to registration process)



Intermediate & final drill will be delivered with R2GATE Guide™



➔ R2GATE Universal Kit

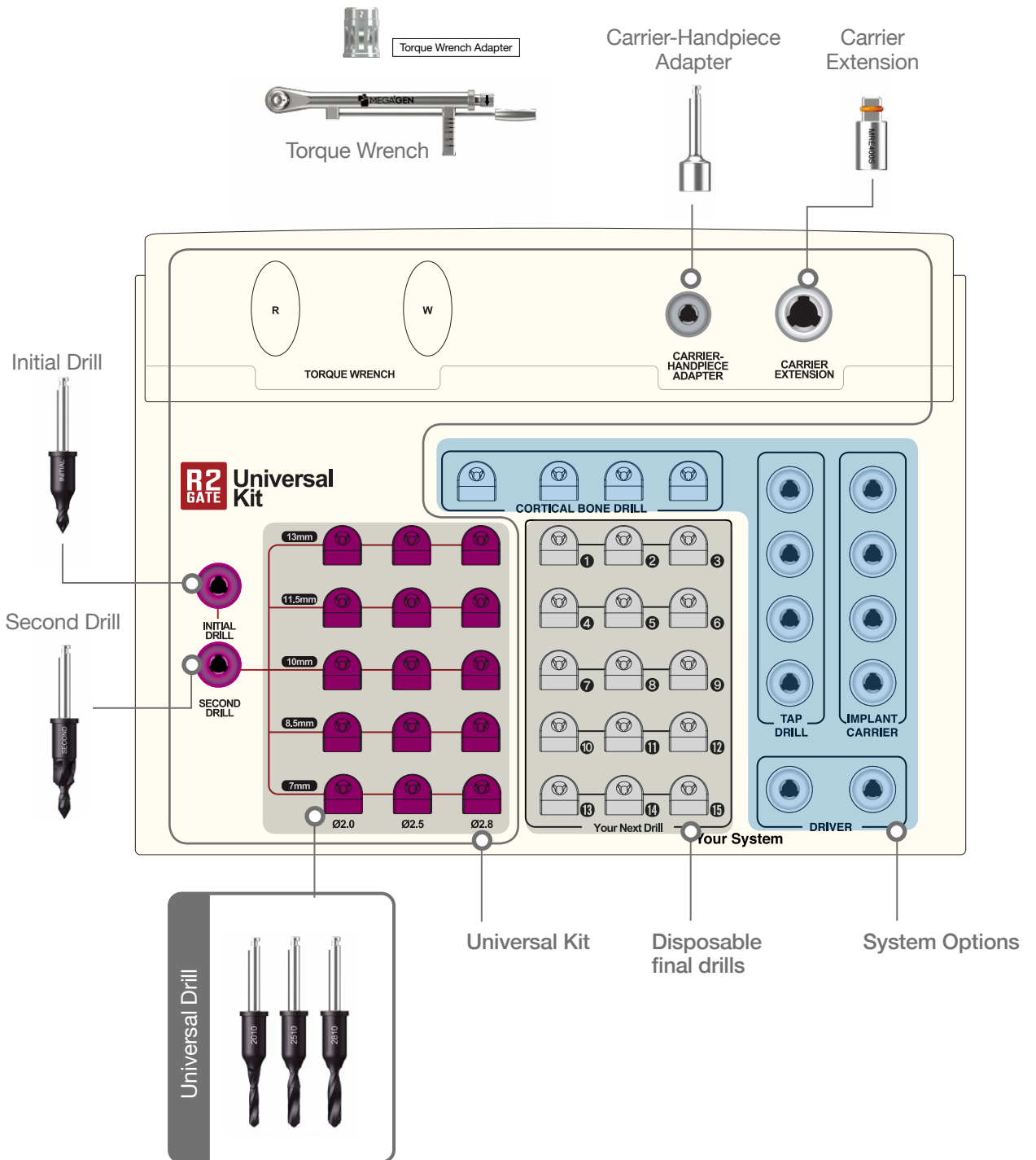

➔ Drills & Components for R2GATE Universal Kit

Basic drilling set for any implant system. It consists of initial drill, 2nd drill, universal drills and essential tools.

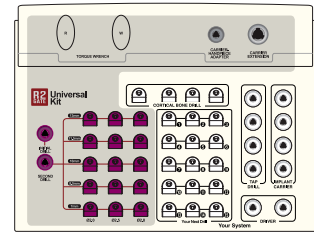

Initial Drill

- Use the initial drill in order to mark the drilling position on the bone. Start drilling slowly, when drill guide part is fully contacted with drilling core of R2GATE Guide™.
- Recommended drilling speed range is 300 ~ 800 RPM with copious irrigation.

Diameter	Guide Diameter	Length(mm)	Ref.C
Ø2.6	Ø5.0	1.0	R2ID2601

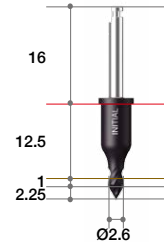

Second Drill

- This unique step-drill(from ø2.0 to ø4.6) is used to flare out the upper cortical bone of the osteotomy.
- It helps not only the rest drilling procedure but abutment connection. In case of hard bone, if the 2nd drilling will be disturbed by thick cortical bone. Stop the drilling and try it after final drilling procedure.

Diameter	Guide Diameter	Length(mm)	Ref.C
Ø2.5	Ø5.0	5.0	R2SD2505



Stopper Drill

- Universal drills consist of ø2.0, ø2.5, ø2.8 diameter to enlarge the osteotomy gradually.
- The length of drill are designed as 7.0, 8.5, 10, 11.5, 13mm for most common length of implant system.
- Recommended drilling speed range is 500 ~ 800 RPM with copious irrigation.

Diameter	Guide Diameter	Length(mm)	Ref.C
Ø2.0	Ø5.0	6.5	R2SD2007
		8.0	R2SD2008
		9.5	R2SD2010
		11.0	R2SD2011
		12.5	R2SD2013
Ø2.5	Ø5.0	6.5	R2SD2507
		8.0	R2SD2508
		9.5	R2SD2510
		11.0	R2SD2511
		12.5	R2SD2513
Ø2.8	Ø5.0	6.5	R2SD2807
		8.0	R2SD2808
		9.5	R2SD2810
		11.0	R2SD2811
		12.5	R2SD2813

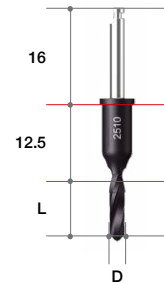

Carrier-Handpiece Adapter

- Useful to use the handpiece for the implant placement following initial delivery of a fixture with a fixture carrier ratchet type.

Square	Ref.C
4.0	AGHA



Carrier Extension

- To extend the length of implant carrier.

Square	Ref.C
4.0	MRE400S

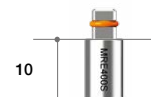

Torque Wrench & Adapter

- Torque Wrench has torque options from 15Ncm to 45Ncm and is used for the placement of an implant and final tightening of the Abutment Screw.

Type	Ref.C
Torque Wrench	TW70
Torque Wrench Adapter(Ratchet)	TTAR100



Cortical Bone Drill[AR]

- Recommended drilling speed : 300 ~ 800 RPM

Diameter	Guide Diameter	Length(mm)	Ref.C
Ø3.4	Ø5.0	5.0	R2CD3405
Ø3.8			R2CD3805
Ø4.3			R2CD4305
Ø4.8			R2CD4805
Ø5.3	Ø6.5	5.0	R2CD5305
Ø5.8			R2CD5805
Ø6.3			R2CD6305

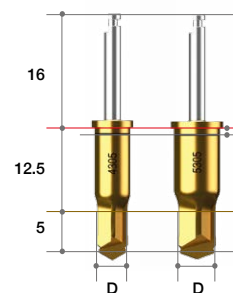

Optional Instrument

Narrow Crest Drill

- It is used when fixture will be slantly implanted or to flat the sloped bone surface of narrow ridge to prevent any slips during drilling.
- Design as 2-piece: drill body and housing
- Can be disassembled. Easy to clean and remove bone chips
- Can harvest autogenous bone if it is used after soft tissue

Diameter	Guide Diameter	Length(mm)	Ref.C
Ø4.0	Ø5.0	15.5(12.5/2)	NCD402

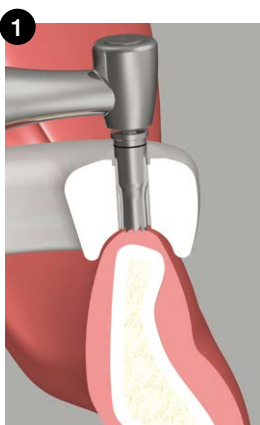
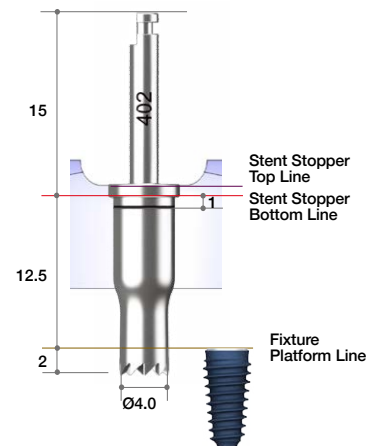
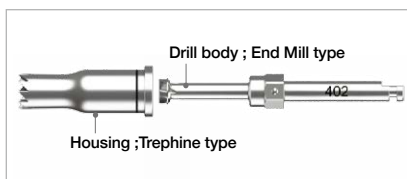

1 Set the site by drilling counter-clockwisely with low speed ($\leq 100\text{rpm}$)

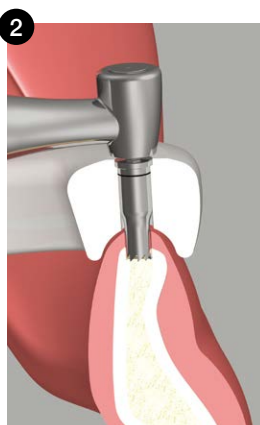

2 Start drilling clockwisely (400~600rpm)

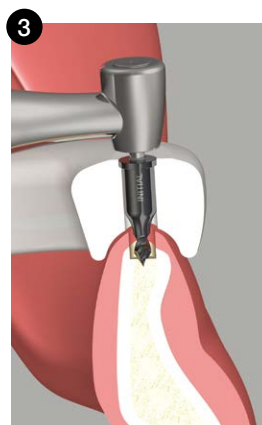

3 Bone is now flat. Perform drilling with proper drilling sequence.

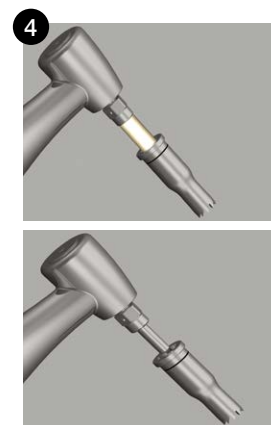

4 Disassemble body and housing after drilling to remove bone chip. Clean and sterilize after every usage.

➔ Final Drill Option [Disposable or Permanent]

Stopper Drill[Straight]

For all implant system

- Common use
- Step back type drilling
- Provided from local R2GATE Design Center to users. The size of disposable drills are decided depend size on treatment planning regarding to fixture size and bone density of patient.
- Recommended drilling speed is 300 ~ 800 RPM.
- Final drill.
- The base is disposable and can be made for permanent under your order

Diameter	Guide Diameter	Length(mm)	Permanent Ref.C	Disposal Ref.C
Ø3.4		7.0	R2PS3407	R2DS3407
		8.0	R2PS3408	R2DS3408
		9.0	R2PS3409	R2DS3409
		10.0	R2PS3410	R2DS3410
		11.0	R2PS3411	R2DS3411
		12.0	R2PS3412	R2DS3412
		13.0	R2PS3413	R2DS3413
Ø3.8	Ø5.0	7.0	R2PS3807	R2DS3807
		8.0	R2PS3808	R2DS3808
		9.0	R2PS3809	R2DS3809
		10.0	R2PS3810	R2DS3810
		11.0	R2PS3811	R2DS3811
		12.0	R2PS3812	R2DS3812
		13.0	R2PS3813	R2DS3813
Ø4.3		7.0	R2PS4307	R2DS4307
		8.0	R2PS4308	R2DS4308
		9.0	R2PS4309	R2DS4309
		10.0	R2PS4310	R2DS4310
		11.0	R2PS4311	R2DS4311
		12.0	R2PS4312	R2DS4312
Ø4.8		7.0	R2PS4807	R2DS4807
		8.0	R2PS4808	R2DS4808
		9.0	R2PS4809	R2DS4809
		10.0	R2PS4810	R2DS4810
		11.0	R2PS4811	R2DS4811
		12.0	R2PS4812	R2DS4812
		13.0	R2PS4813	R2DS4813
Ø5.3	Ø6.5	7.0	R2PS5307	R2DS5307
		8.0	R2PS5308	R2DS5308
		9.0	R2PS5309	R2DS5309
		10.0	R2PS5310	R2DS5310
		11.0	R2PS5311	R2DS5311
		12.0	R2PS5312	R2DS5312
		13.0	R2PS5313	R2DS5313
Ø5.8		7.0	R2PS5807	R2DS5807
		8.0	R2PS5808	R2DS5808
		9.0	R2PS5809	R2DS5809
		10.0	R2PS5810	R2DS5810
		11.0	R2PS5811	R2DS5811
		12.0	R2PS5812	R2DS5812
		13/0	R2PS5813	R2DS5813

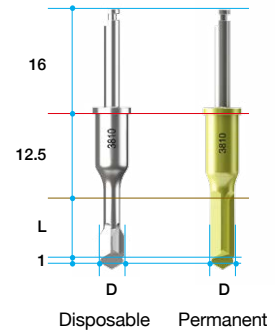

Drill position on the kit

- Every disposable drills have the numbering system to clarify it's own position on the universal kit.
- Check the drill size and position number, then install it to the right position.

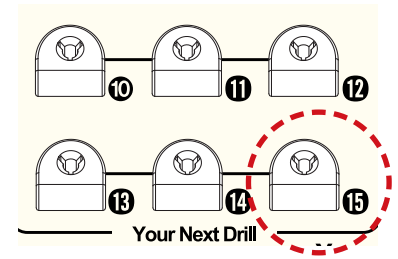
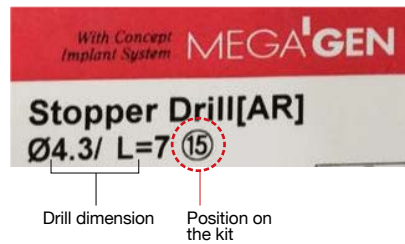

Sterilized package

- All disposable drills are packaged at clean room and sterilized by "Gamma-ray".
- Check the "Sterilized" seal on the package and open it at the operation site before surgery.



Digital Material

I. ZrGEN®

ZrGEN® is the brand name of MegaGen Titanium Base. ZrGEN provides an aesthetic outcome and simplified dental implant prosthesis. A ZrGEN® crown and monolithic crown connected to a ZrGEN® Abutment provide strong and precise connection with the implant fixture.

Variety of ZrGEN®



ZrGEN Coping



PMMA Provisional Crown



ZrGEN Monolithic



ZrGEN Crown



ZrGEN Bridge



ZrGEN Coping for PFZ

ZrGEN® Sub Structure



ZrGEN



Zirconia customized body



Zirconia Final Crown

ZrGEN®

The strength of ZrGEN® frees you from the chipping of conventional PFM prosthesis. Monolithic zirconia crowns have no metal substructure, ensuring more aesthetic results. ZrGEN® crown and bridge are a superior substitutes for all conventional dental materials.



Tooth shade cuff area



Minimized Ti-connection

Clinical Application



II. TiGEN®

TiGEN® is the brand name of MegaGen Titanium customized abutment. It promises outstanding durability and simplified dental implant prosthesis. Ready-made connection part provides a strong and precise connection with the implant fixture.

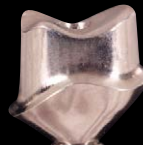

➔ ZrGEN® Prosthesis



ZrGEN® Abutment

ZrGEN® Abutment provides a strong and precise connection with the implant fixture. With Zirconia® coping, crown margins can be placed supragingivally since zirconia material matches with the color of natural teeth. Residual cement problems are no longer an issue.

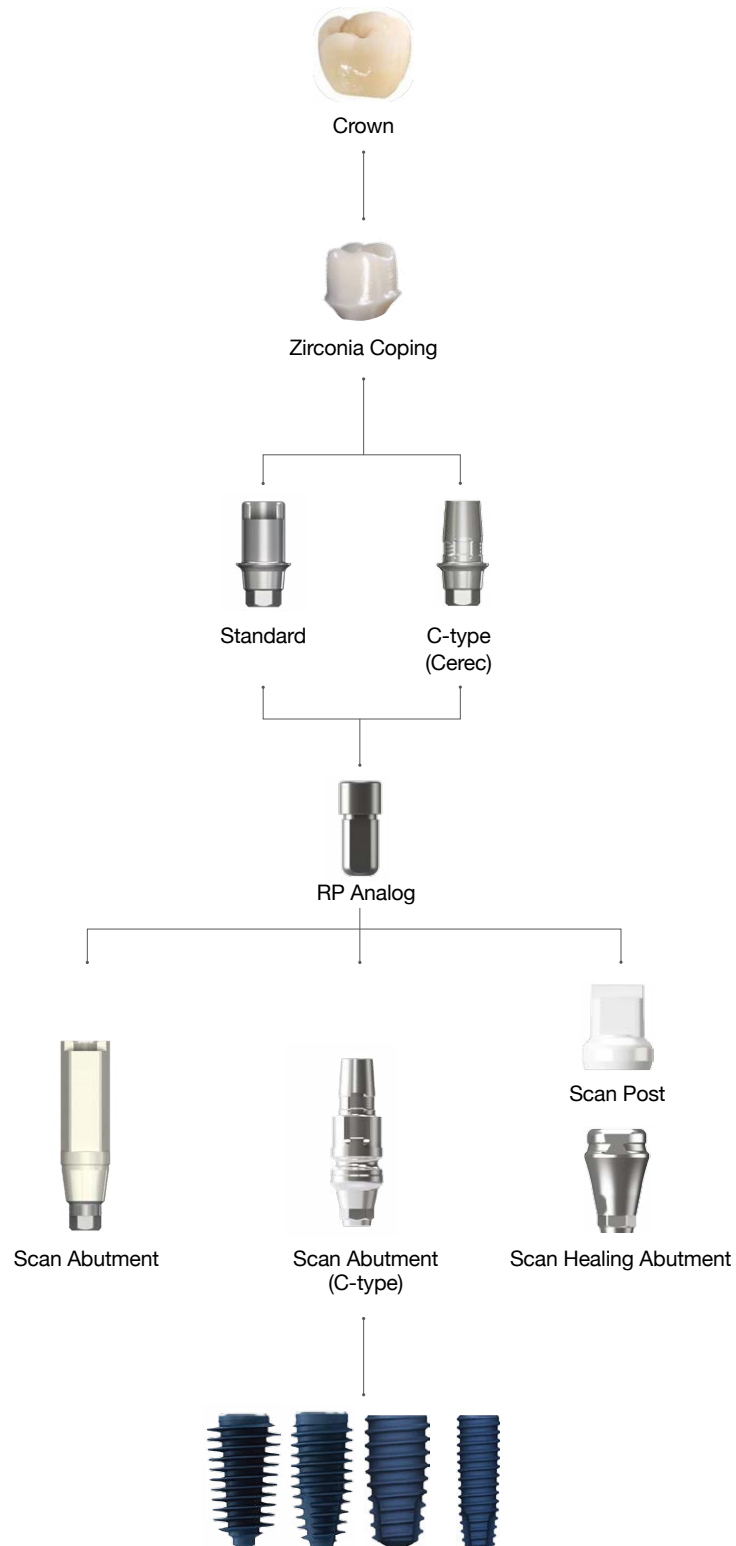

➔ Scan Abutment Option

Scan Abutment

- Abutment Screw included.
- . AnyRidge (AANMSF)
- . AnyRidge Octa 1 (AROAS16B/ AROAS16)
- . AnyOne Internal (AS20)
- . AnyOne Exeternal (SCS160/ RCS200)
- . AnyOne OneStage (EXIMS100)
- . MiNi (MIAS14)
- . ST (OSGSAS3110/ OSGSAS3210)
- . Octa Level (IRCS200)
- . Multi-unit Abutment (MUAS)

- For Chairside/ Labside
- Included spare Abutment Screw
- Supporting Dental CAD
 - 3 Shape
 - Exocad
 - Dental Wings

System	Profile Diameter	Length (mm)	Type	Ref.C
AnyRidge	Ø4.0	9	-	AANISR4009T
		13	-	AANISR4013T
AnyRidge Octa 1	Ø4.0	13	NC	AROSANT
			RC	AROSART
AnyOne Internal	Ø4.0	9	-	AAOISR4009T
		13	-	AAOISR4013T
AnyOne External	Ø4.0	9	Small	AEXESS4009T
			13	AEXESS4013T
			Regular	AEXESR4009T
AnyOne OneStage	Ø4.0	13	Cuff 1.8	AEXISR4010T
MiNi	3.5	9	-	MISS3509T
		13	-	MISS3513T
ST	Ø4.0	9	Small	OSGSSC3110T
			13	OSGSSC3111T
		9	Regular	OSGSSC3210T
			13	OSGSSC3211T
Octa Level	Ø4.0	11	-	AOCESC4011T
MUA Level (N-Type)	Ø4.0	13	-	AMUASR4013T



Scan Abutmet (C-type)

- Abutment Screw included.
- . AnyRidge (AANMSF)
- . AnyOne (AS20)
- . AnyRidge Octa 1 (AROAS16B/ AROAS16)

- Scan Post for Sirona Cerec users → CEREC
- In in Lab CAD Software, compatible with
- Xive Library

System	Profile Diameter	Cuff Height	Post Size	Ref.C
AnyRidge	Ø3.9	0.5	Small	ARICSS3405T
		1		ARICSS3410T
		2		ARICSS3420T
	Ø4.3	0.5	Small	ARICSS3805T
		1		ARICSS3810T
		2		ARICSS3820T
AnyRidge Octa 1	Ø3.9	0.5	Small	ARICSL4505T
		1		ARICSL4510T
		2		ARICSL4520T
	Ø4.3	0.5	Small	AROCSS3405NT
		1		AROCSS3410NT
		2		AROCSS3420NT
AnyOne	Ø3.9	0.5	Small	AROCSS3805NT
		1		AROCSS3810NT
		2		AROCSS3820NT
	Ø4.3	0.5	Small	AROCSS3405RT
		1		AROCSS3410RT
		2		AROCSS3420RT
AnyOne	Ø4.3	0.5	Small	AROCSS3805RT
		1		AROCSS3810RT
		2		AROCSS3820RT
	Ø5.5	0.5	Large	AROCSS3820RT
		1		AROCSS3820RT
		2		AROCSS3820RT
AnyOne	Ø3.9	0.5	Small	AROCSS3405T
		1		AROCSS3410T
		2		AROCSS3420T
	Ø4.3	0.5	Small	AOICSS3805T
		1		AOICSS3810T
		2		AOICSS3820T
	Ø5.5	0.5	Large	AOICSS3820T
		1		AOICSS3820T
		2		AOICSS3820T

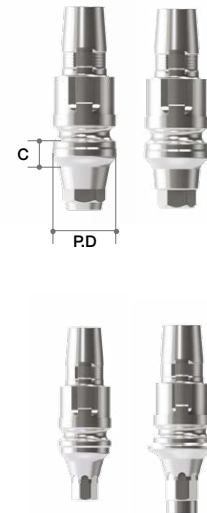

Scan Healing Abutment & Scan Post

- Abutment Screw included.
- AnyRidge (ARIHS1804/ARIHS1805/ARIHS1807)
- AnyOne (AOIHS2004/AOIHS2005/AOIHS2007)
- AnyRidge Octa 1 (AROHS1604/AROHS1605/ AROHS1607)

- Can get scan data without removing Scan Healing Abutment from Scan Post
- Different colors depend on the cuff size
- Scan healing abutment should be exposed 2.0mm on the surgical site for accurate scanning

- Scan Healing Abutment should be exposed 2.0mm from the surgical site for accurate scanning. Scanning would be much easier if you connect Scan Post when scanning seems difficult due to less exposure of Scan Healing Abutment or other conditions.
- Select Scan Post based on the diameter of Scan Healing Abutment
- Scan Post is a disposable product and sold separately in batch of 10EA. for each package

System	Profile Diameter	Scan Post	Height (mm)	Ref.C
AnyRidge	Ø4.0	SP4007.MTN	4	ARISH4004T
			5	ARISH4005T
			7	ARISH4007T
	Ø5.0	SP5007.MTN	4	ARISH5004T
			5	ARISH5005T
			7	ARISH5007T
	Ø6.0	SP6007.MTN	4	ARISH6004T
			5	ARISH6005T
			7	ARISH6007T
	Ø7.0	SP7007.MTN	4	ARISH7004T
			5	ARISH7005T
			7	ARISH7007T
Ø5.0 (Extra type)	SP5007.MTN	4	ARNSH5004T	
		5	ARNSH5005T	
		7	ARNSH5007T	
Ø6.0 (Extra type)	SP6007.MTN	4	ARNSH6004T	
		5	ARNSH6005T	
		7	ARNSH6007T	
AnyRidge Octa 1	Ø4.0	SP4007.MTN	4	AROISHN4004T
			5	AROISHN4005T
			7	AROISHN4007T
	Ø5.0	SP5007.MTN	4	AROISHN5004T
			5	AROISHN5005T
			7	AROISHN5007T
	Ø4.0	SP4007.MTN	4	AROISHR4004T
			5	AROISHR4005T
			7	AROISHR4007T
	Ø5.0	SP5007.MTN	4	AROISHR5004T
			5	AROISHR5005T
			7	AROISHR5007T
Ø6.0	SP6007.MTN	4	AROISHR6004T	
		5	AROISHR6005T	
		7	AROISHR6007T	
Ø7.0	SP7007.MTN	4	AROISHR7004T	
		5	AROISHR7005T	
		7	AROISHR7007T	
AnyOne	Ø4.0	SP4007.MTN	4	AOISH4004T
			5	AOISH4005T
			7	AOISH4007T
	Ø4.5	SP5007.MTN	4	AOISH4504T
			5	AOISH4505T
			7	AOISH4507T
	Ø5.5	SP6007.MTN	4	AOISH5504T
			5	AOISH5505T
			7	AOISH5507T
	Ø6.5	SP7007.MTN	4	AOISH6504T
			5	AOISH6505T
			7	AOISH6507T

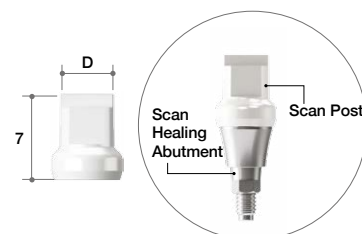

* If Scan Healing Abutment is exposed more than 2.5mm, it may destabilize a fixture and results in fixture failure.



Scan Post Carrier

System	Length	Ref.C
Common	19	SPC16



➔ RP Analog Option

RP Analog

- For Chairside/ Labside
- Included spare Abutment Screw
- Supporting Dental CAD
 - 3 Shape
 - Exocad

System	Profile Diameter	Length (mm)	Type	Ref.C
AnyRidge	Ø4.0	9	-	CANIAR4009
AnyRidge Octa 1	Ø3.3	10	NC	AROLAN
	Ø4.1		RC	AROLAR
AnyOne Internal	Ø4.0	9	Only Ø3.5	CAOIAS3509
			-	CAOJAR4009
AnyOne External	Ø3.5	9	Small	CEXEAS3509
	Ø4.1		Regular	CEXEAR4109
	Ø5.0		Wide	CEXEA5009
AnyOne OneStage	Ø4.8	9	Cuff 1.8	OSRA18
MINi	Ø3.0	9	-	CMIIAN3009
ST	Ø3.7	9	Small	OSRA3709
	Ø4.3		Regular	OSRA4309
Octa Level	Ø3.8	9	Small	OCTARA4
	Ø4.8		Regular	OCTARA5
	Ø5.8		Wide	OCTARA6
MUA Level (N-Type)	Ø4.8	9	-	MUALA



NEW!!

➔ ZrGEN Abutment Option

ZrGEN Abutment

- Abutment Screw included.
 - . AnyRidge (AANMSF)
 - . AnyOne Internal (AS20)
 - . AnyOne Exeternal(SCS160/ RCS200)
 - . AnyOne Stage (
 - . MiNi (MIAZ1410)
 - . ST(OSGSAS3110/OSGSAS3210)
 - . Octa Level(IRCS200)
 - . AnyRidge Octa 1(AROAS16B/ AROAS16)
- Titanium Base
- 1Set(=Abutment 10ea)
 - included spare Abutment Screw
 - MiNi ZrGEN has special ZrGEN Screw
- Supporting DentalCAD
 - 3 Shape
 - Exocad
 - Dental Wing
- Different groove number depend on the post size
 - P=4.5 ▶ groove number : 2ea
 - P=5 ▶ groove number : 3ea
 - P=6 ▶ groove number : 4ea
 - P=8 ▶ groove number : 6ea

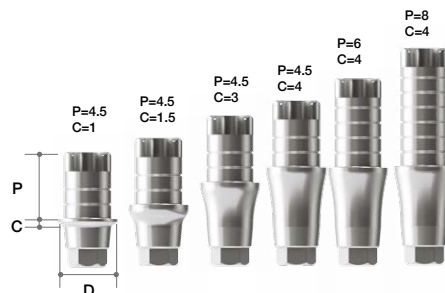

Standard

System	Diameter	Cuff Height	Post Height	Type	Ref.C		
AnyRidge	Ø4.0	0.6	4.5	Hex	AANIPR4015.MTN		
			6		AANIPR4016.MTN		
			8		AANIPR4018.MTN		
		1.5	4.5		AANIPR4025.MTN		
			6		AANIPR4026.MTN		
			8		AANIPR4028.MTN		
		3.0	4.5		AANIPR4035.MTN		
			6		AANIPR4036.MTN		
			8		AANIPR4038.MTN		
		4.0	4.5		AANIPR4045.MTN		
			6		AANIPR4046.MTN		
			8		AANIPR4048.MTN		
		Ø4.5	0.6	4.5	Hex	AANIPR4015N.MTN	
				6		AANIPR4016N.MTN	
				8		AANIPR4018N.MTN	
				1.5		4.5	AANIPR4025N.MTN
						6	AANIPR4026N.MTN
						8	AANIPR4028N.MTN
				3.0		4.5	AANIPR4035N.MTN
						6	AANIPR4036N.MTN
						8	AANIPR4038N.MTN
				4.0		4.5	AANIPR4045N.MTN
						6	AANIPR4046N.MTN
						8	AANIPR4048N.MTN
	0.6		4.5	Non-Hex		AANIPR4515.MTN	
			6			AANIPR4516.MTN	
			8			AANIPR4518.MTN	
			1.5			4.5	AANIPR4525.MTN
						6	AANIPR4526.MTN
						8	AANIPR4528.MTN
			3.0			4.5	AANIPR4535.MTN
						6	AANIPR4536.MTN
						8	AANIPR4538.MTN
			4.0			4.5	AANIPR4545.MTN
						6	AANIPR4546.MTN
						8	AANIPR4548.MTN
	0.6	4.5	Non-Hex	AANIPR4515N.MTN			
		6		AANIPR4516N.MTN			
		8		AANIPR4518N.MTN			
		1.5		4.5	AANIPR4525N.MTN		
				6	AANIPR4526N.MTN		
				8	AANIPR4528N.MTN		
		3.0		4.5	AANIPR4535N.MTN		
				6	AANIPR4536N.MTN		
				8	AANIPR4538N.MTN		
		4.0		4.5	AANIPR4545N.MTN		
				6	AANIPR4546N.MTN		
				8	AANIPR4548N.MTN		
AnyRidge Octa 1	Ø4.0	0.6		NC	AROZGN4015.MTN		
					1.5	AROZGN4025.MTN	
					3.0	AROZGN4035.MTN	
		4.0			4.0	AROZGN4045.MTN	
					0.6	AROZGN4016.MTN	
					1.5	AROZGN4026.MTN	
		6.0			3.0	AROZGN4036.MTN	
					4.0	AROZGN4046.MTN	
					0.6	AROZGN4018.MTN	
		8.0			1.5	AROZGN4028.MTN	
					3.0	AROZGN4038.MTN	
					4.0	AROZGN4048.MTN	
	Ø4.5	4.5	0.6		AROZGR4515.MTN		
			1.5		AROZGR4525.MTN		
			3.0		AROZGR4535.MTN		
			4.0		AROZGR4545.MTN		
			6.0		0.6	AROZGR4516.MTN	
					1.5	AROZGR4526.MTN	
		3.0			AROZGR4536.MTN		
		4.0			AROZGR4546.MTN		
		8.0			0.6	AROZGR4518.MTN	
					1.5	AROZGR4528.MTN	
			3.0		AROZGR4538.MTN		
			4.0		AROZGR4548.MTN		
MUA Level	Ø5.5		0.8	N-Type (Nobel)	AMUAPR5515N.MTN		
					6	AMUAPR5516N.MTN	
		8			AMUAPR5518N.MTN		
		1.7	5		AMUAPR5525N.MTN		
			6		AMUAPR5526N.MTN		
			8		AMUAPR5528N.MTN		
	3.0	5	AMUAPR5535N.MTN				
		6	AMUAPR5536N.MTN				
		8	AMUAPR5538N.MTN				
	4.0	5	AMUAPR5545N.MTN				
		6	AMUAPR5546N.MTN				
		8	AMUAPR5548N.MTN				

Standard

System	Diameter	Cuff Height	Post Height	Type	Ref.C			
AnyOne Internal	Ø4.0	0.6	4.5	Hex	AAOIPR4015.MTN			
			6		AAOIPR4016.MTN			
			8		AAOIPR4018.MTN			
		1.5	4.5		AAOIPR4025.MTN			
			6		AAOIPR4026.MTN			
			8		AAOIPR4028.MTN			
		3.0	4.5		AAOIPR4035.MTN			
			6		AAOIPR4036.MTN			
			8		AAOIPR4038.MTN			
		4.0	4.5	AAOIPR4045.MTN				
			6	AAOIPR4046.MTN				
			8	AAOIPR4048.MTN				
		Ø4.5	0.6	4.5	Hex	AAOIPR4015N.MTN		
				6		AAOIPR4016N.MTN		
				8		AAOIPR4018N.MTN		
				1.5		4.5	AAOIPR4025N.MTN	
						6	AAOIPR4026N.MTN	
						8	AAOIPR4028N.MTN	
	3.0		4.5	AAOIPR4035N.MTN				
			6	AAOIPR4036N.MTN				
			8	AAOIPR4038N.MTN				
	4.0		4.5	AAOIPR4045N.MTN				
			6	AAOIPR4046N.MTN				
			8	AAOIPR4048N.MTN				
	Ø4.5		0.6	4.5		Hex	AAOIPR4515.MTN	
				6			AAOIPR4516.MTN	
				8			AAOIPR4518.MTN	
				1.5			4.5	AAOIPR4525.MTN
							6	AAOIPR4526.MTN
							8	AAOIPR4528.MTN
		3.0	4.5	AAOIPR4535.MTN				
			6	AAOIPR4536.MTN				
			8	AAOIPR4538.MTN				
		4.0	4.5	AAOIPR4545.MTN				
			6	AAOIPR4546.MTN				
			8	AAOIPR4548.MTN				
		Ø4.5	0.6	4.5	Non-Hex		AAOIPR4515N.MTN	
				6			AAOIPR4516N.MTN	
				8			AAOIPR4518N.MTN	
				1.5			4.5	AAOIPR4525N.MTN
							6	AAOIPR4526N.MTN
							8	AAOIPR4528N.MTN
	3.0		4.5	AAOIPR4535N.MTN				
			6	AAOIPR4536N.MTN				
			8	AAOIPR4538N.MTN				
	4.0		4.5	AAOIPR4545N.MTN				
			6	AAOIPR4546N.MTN				
			8	AAOIPR4548N.MTN				

System	Diameter	Cuff Height	Post Height	Type	Ref.C			
AnyOne External	Small	Ø4.2	0.6	Hex	AEXEPS4015.MTN			
					6	AEXEPS4016.MTN		
					8	AEXEPS4018.MTN		
			1.5		4.5	AEXEPS4025.MTN		
					6	AEXEPS4026.MTN		
					8	AEXEPS4028.MTN		
		3.0	4.5		AEXEPS4035.MTN			
			6		AEXEPS4036.MTN			
			8		AEXEPS4038.MTN			
		4.0	4.5		AEXEPS4045.MTN			
			6		AEXEPS4046.MTN			
			8		AEXEPS4048.MTN			
		Ø4.5	0.6		4.5	Hex	AEXEPS4515.MTN	
							6	AEXEPS4516.MTN
							8	AEXEPS4518.MTN
					1.5		4.5	AEXEPS4525.MTN
							6	AEXEPS4526.MTN
							8	AEXEPS4528.MTN
	3.0		4.5	AEXEPS4535.MTN				
			6	AEXEPS4536.MTN				
			8	AEXEPS4538.MTN				
	4.0		4.5	AEXEPS4545.MTN				
			6	AEXEPS4546.MTN				
			8	AEXEPS4548.MTN				
	Regular		Ø4.5	0.6	Hex		AEXEPR4515.MTN	
							6	AEXEPR4516.MTN
							8	AEXEPR4518.MTN
				1.5			4.5	AEXEPR4525.MTN
							6	AEXEPR4526.MTN
							8	AEXEPR4528.MTN
		3.0	4.5	AEXEPR4535.MTN				
			6	AEXEPR4536.MTN				
			8	AEXEPR4538.MTN				
		4.0	4.5	AEXEPR4545.MTN				
			6	AEXEPR4546.MTN				
			8	AEXEPR4548.MTN				
		Wide	Ø5.5	0.6		Hex	AEXEPW5515.MTN	
							6	AEXEPW5516.MTN
							8	AEXEPW5518.MTN
				1.5			4.5	AEXEPW5525.MTN
							6	AEXEPW5526.MTN
							8	AEXEPW5528.MTN
	3.0		4.5	AEXEPW5535.MTN				
			6	AEXEPW5536.MTN				
			8	AEXEPW5538.MTN				
	4.0		4.5	AEXEPW5545.MTN				
			6	AEXEPW5546.MTN				
			8	AEXEPW5548.MTN				
AnyOne OneStage	Cuff 1.8		Ø4.8	Octa	AEXIPR5015.MTN			
					0.6		6	AEXIPR5016.MTN
							8	AEXIPR5018.MTN
							1.5	4.5
					6			AEXIPR5026.MTN
					8			AEXIPR5028.MTN
		3.0	4.5		AEXIPR5035.MTN			
			6		AEXIPR5036.MTN			
			8		AEXIPR5038.MTN			
		4.0	4.5		AEXIPR5045.MTN			
			6		AEXIPR5046.MTN			
			8		AEXIPR5048.MTN			



Extra

System	Fixture Core	Diameter	Cuff Height	Post Height	Type	Ref.C	
AnyRidge	Core 3.3	Ø4.5	0.6	4.5	Hex	ARZXM4515.MTN	
				6		ARZXM4516.MTN	
				8		ARZXM4518.MTN	
			1.5	4.5		ARZXM4525.MTN	
				6		ARZXM4526.MTN	
				8		ARZXM4528.MTN	
			3.0	4.5		ARZXM4535.MTN	
				6		ARZXM4536.MTN	
				8		ARZXM4538.MTN	
			4.0	4.5		ARZXM4545.MTN	
				6		ARZXM4546.MTN	
				8		ARZXM4548.MTN	
			Non -Hex	0.6		4.5	ARZXM4515N.MTN
						6	ARZXM4516N.MTN
						8	ARZXM4518N.MTN
				1.5		4.5	ARZXM4525N.MTN
						6	ARZXM4526N.MTN
						8	ARZXM4528N.MTN
				3.0		4.5	ARZXM4535N.MTN
						6	ARZXM4536N.MTN
						8	ARZXM4538N.MTN
				4.0		4.5	ARZXM4545N.MTN
						6	ARZXM4546N.MTN
						8	ARZXM4548N.MTN
	Core3.8	Ø5.0	0.6	4.5	Hex	ARZXM503815.MTN	
				6		ARZXM503816.MTN	
				8		ARZXM503818.MTN	
			1.5	4.5		ARZXM503825.MTN	
				6		ARZXM503826.MTN	
				8		ARZXM503828.MTN	
			3.0	4.5		ARZXM503835.MTN	
				6		ARZXM503836.MTN	
				8		ARZXM503838.MTN	
			4.0	4.5		ARZXM503845.MTN	
				6		ARZXM503846.MTN	
				8		ARZXM503848.MTN	
		Non -Hex	0.6	4.5		ARZXM503815N.MTN	
				6		ARZXM503816N.MTN	
				8		ARZXM503818N.MTN	
			1.5	4.5		ARZXM503825N.MTN	
				6		ARZXM503826N.MTN	
				8		ARZXM503828N.MTN	
			3.0	4.5		ARZXM503835N.MTN	
				6		ARZXM503836N.MTN	
				8		ARZXM503838N.MTN	
			4.0	4.5		ARZXM503845N.MTN	
				6		ARZXM503846N.MTN	
				8		ARZXM503848N.MTN	
Core3.8	Ø5.5	0.6	4.5	Hex	ARZXM553815.MTN		
			6		ARZXM553816.MTN		
			8		ARZXM553818.MTN		
		1.5	4.5		ARZXM553825.MTN		
			6		ARZXM553826.MTN		
			8		ARZXM553828.MTN		
		3.0	4.5		ARZXM553835.MTN		
			6		ARZXM553836.MTN		
			8		ARZXM553838.MTN		
		4.0	4.5		ARZXM553845.MTN		
			6		ARZXM553846.MTN		
			8		ARZXM553848.MTN		
	Non -Hex	0.6	4.5		ARZXM553815N.MTN		
			6		ARZXM553816N.MTN		
			8		ARZXM553818N.MTN		
		1.5	4.5		ARZXM553825N.MTN		
			6		ARZXM553826N.MTN		
			8		ARZXM553828N.MTN		
		3.0	4.5		ARZXM553835N.MTN		
			6		ARZXM553836N.MTN		
			8		ARZXM553838N.MTN		
		4.0	4.5		ARZXM553845N.MTN		
			6		ARZXM553846N.MTN		
			8		ARZXM553848N.MTN		

Extra

System	Fixture Core	Diameter	Cuff Height	Post Height	Type	Ref.C
AnyRidge	Core4.0	Ø5.0	0.6	4.5	Hex	ARZXM5015.MTN
				6		ARZXM5016.MTN
				8		ARZXM5018.MTN
			1.5	4.5		ARZXM5025.MTN
				6		ARZXM5026.MTN
				8		ARZXM5028.MTN
			3.0	4.5		ARZXM5035.MTN
				6		ARZXM5036.MTN
				8		ARZXM5038.MTN
			4.0	4.5		ARZXM5045.MTN
				6		ARZXM5046.MTN
				8		ARZXM5048.MTN
		Ø5.5	0.6	4.5	Non -Hex	ARZXM5015N.MTN
				6		ARZXM5016N.MTN
				8		ARZXM5018N.MTN
			1.5	4.5		ARZXM5025N.MTN
				6		ARZXM5026N.MTN
				8		ARZXM5028N.MTN
			3.0	4.5		ARZXM5035N.MTN
				6		ARZXM5036N.MTN
				8		ARZXM5038N.MTN
			4.0	4.5		ARZXM5045N.MTN
				6		ARZXM5046N.MTN
				8		ARZXM5048N.MTN
		Ø5.5	0.6	4.5	Hex	ARZXM5515.MTN
				6		ARZXM5516.MTN
				8		ARZXM5518.MTN
				4.5		ARZXM5525.MTN
				6		ARZXM5526.MTN
				8		ARZXM5528.MTN
			3.0	4.5	ARZXM5535.MTN	
				6	ARZXM5536.MTN	
				8	ARZXM5538.MTN	
				4.5	ARZXM5545.MTN	
				6	ARZXM5546.MTN	
				8	ARZXM5548.MTN	
			0.6	4.5	Non -Hex	ARZXM5515N.MTN
				6		ARZXM5516N.MTN
				8		ARZXM5518N.MTN
				4.5		ARZXM5525N.MTN
				6		ARZXM5526N.MTN
				8		ARZXM5528N.MTN
			3.0	4.5	ARZXM5535N.MTN	
				6	ARZXM5536N.MTN	
				8	ARZXM5538N.MTN	
				4.5	ARZXM5545N.MTN	
				6	ARZXM5546N.MTN	
				8	ARZXM5548N.MTN	

System	Fixture Core	Diameter	Cuff Height	Post Height	Type	Ref.C
AnyRidge	Core 4.8	Ø5.5	0.6	4.5	Hex	ARZXL5515.MTN
				6		ARZXL5516.MTN
				8		ARZXL5518.MTN
			1.5	4.5		ARZXL5525.MTN
				6		ARZXL5526.MTN
				8		ARZXL5528.MTN
			3.0	4.5		ARZXL5535.MTN
				6		ARZXL5536.MTN
				8		ARZXL5538.MTN
			4.0	4.5		ARZXL5545.MTN
				6		ARZXL5546.MTN
				8		ARZXL5548.MTN
		Ø6.0	0.6	4.5	Hex	ARZXL6015.MTN
				6		ARZXL6016.MTN
				8		ARZXL6018.MTN
				4.5		ARZXL6025.MTN
				6		ARZXL6026.MTN
				8		ARZXL6028.MTN
			3.0	4.5	ARZXL6035.MTN	
				6	ARZXL6036.MTN	
				8	ARZXL6038.MTN	
				4.5	ARZXL6045.MTN	
				6	ARZXL6046.MTN	
				8	ARZXL6048.MTN	
		0.6	4.5	Non -Hex	ARZXL6015N.MTN	
			6		ARZXL6016N.MTN	
			8		ARZXL6018N.MTN	
			4.5		ARZXL6025N.MTN	
			6		ARZXL6026N.MTN	
			8		ARZXL6028N.MTN	
		3.0	4.5	ARZXL6035N.MTN		
			6	ARZXL6036N.MTN		
			8	ARZXL6038N.MTN		
			4.5	ARZXL6045N.MTN		
			6	ARZXL6046N.MTN		
			8	ARZXL6048N.MTN		

- ZrGEN Abutment

- Ti-base for Sirona Cerec users → CEREC
- In in Lab CAD Software, compatible with Xive Library

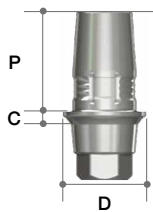

C-Type

System	Diameter	Cuff Height	Post Height	Post Size	Ref.C		
AnyRidge	Ø3.9	0.5	4.7	Small	ARCS3405.MTN		
		1			ARCS3410.MTN		
		2			ARCS3420.MTN		
	Ø4.3	0.5			ARCS3805.MTN		
		1			ARCS3810.MTN		
		2			ARCS3820.MTN		
	Ø5.5	0.5		Large	ARCL4505.MTN		
		1			ARCL4510.MTN		
		2			ARCL4520.MTN		
AnyRidge Octa 1	Ø3.9	0.5	4.5	Small	AROCNS3405.MTN		
		1.0			AROCNS3410.MTN		
		2.0			AROCNS3420.MTN		
		Ø4.3			0.5	AROCNS3805.MTN	
					1.0	AROCNS3810.MTN	
					2.0	AROCNS3820.MTN	
	Ø3.9	0.5		Small	AROCSR3405.MTN		
		1.0			AROCSR3410.MTN		
		2.0			AROCSR3420.MTN		
		Ø4.3			0.5	AROCSR3805.MTN	
					1.0	AROCSR3810.MTN	
					2.0	AROCSR3820.MTN	
	Ø5.5	0.5		Large	AROCLR4505.MTN		
		1.0			AROCLR4510.MTN		
		2.0			AROCLR4520.MTN		
	AnyOne	Ø3.9		0.5	4.7	Small	AOCS3405.MTN
				1			AOCS3410.MTN
				2			AOCS3420.MTN
Ø4.3		0.5	AOCS3805.MTN				
		1	AOCS3810.MTN				
		2	AOCS3820.MTN				
Ø5.5		0.5	Large	AOCL4505.MTN			
		1		AOCL4510.MTN			
		2		AOCL4520.MTN			
ST	Ø3.9	0.5	4.7	Small	STCSS3405.MTN		
		1			STCSS3410.MTN		
		2			STCSS3420.MTN		
		Ø4.3			0.5	STCSS3805.MTN	
					1	STCSS3810.MTN	
					2	STCSS3820.MTN	
	Ø3.9	0.5		Small	STCSR3405.MTN		
		1			STCSR3410.MTN		
		2			STCSR3420.MTN		
		Ø4.3			0.5	STCSR3805.MTN	
					1	STCSR3810.MTN	
					2	STCSR3820.MTN	
	Ø5.5	0.5		Large	STCLR4505.MTN		
		1			STCLR4510.MTN		
		2			STCLR4520.MTN		

Scan Abutmet (C-type)

- Abutment Screw included.
 - . AnyRidge (AANMSF)
 - . AnyOne (AS20)
 - . AnyRidge Octa 1 (AROAS16B/ AROAS16)

- Scan Post for Sirona Cerec users → CEREC
- In in Lab CAD Software, compatible with
- Xive Library

System	Profile Diameter	Cuff Height	Post Size	Ref.C		
AnyRidge	Ø3.9	0.5	Small	ARICSS3405T		
		1		ARICSS3410T		
		2		ARICSS3420T		
	Ø4.3	0.5		ARICSS3805T		
		1		ARICSS3810T		
		2		ARICSS3820T		
	Ø5.5	0.5		Large	ARICSL4505T	
		1			ARICSL4510T	
		2			ARICSL4520T	
AnyRidge Octa 1	Ø3.9	0.5	Small	AROCSS3405NT		
		1		AROCSS3410NT		
		2		AROCSS3420NT		
	Ø4.3	0.5		AROCSS3805NT		
		1		AROCSS3810NT		
		2		AROCSS3820NT		
	Ø3.9	0.5		Small	AROCSS3405RT	
		1			AROCSS3410RT	
		2			AROCSS3420RT	
	Ø4.3	0.5			AROCSS3805RT	
		1			AROCSS3810RT	
		2			AROCSS3820RT	
	Ø5.5	0.5			Large	AROCSL4505RT
		1				AROCSL4510RT
		2				AROCSL4520RT
AnyOne	Ø3.9	0.5	Small	AOICSS3405T		
		1		AOICSS3410T		
		2		AOICSS3420T		
	Ø4.3	0.5		AOICSS3805T		
		1		AOICSS3810T		
		2		AOICSS3820T		
	Ø5.5	0.5		Large	AOICSL4505T	
		1			AOICSL4510T	
		2			AOICSL4520T	

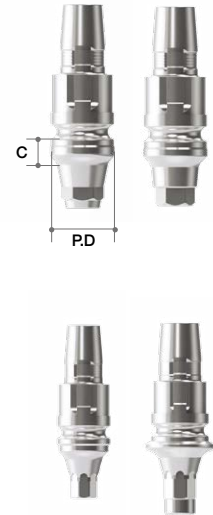

➡ TiGEN Prosthesis



➔ TiGEN Abutment Option

TiGEN Abutment

- Abutment Screw included.
- . AnyRidge (AANMSF)
- . AnyOne Internal (AS20)
- . AnyOne External(SCS160/ RCS200)
- . AnyOne Stage (
- . MiNi (MAZ1410)
- . ST(OSGSAS3110/OSGSAS3210)
- . Octa Level(IRCS200)
- . AnyRidge Octa 1(AROAS16B/ AROAS16)

- Pre-milled Abutment
- 1Set(=Abutment 10ea)
- included spare Abutment Screw
- Supporting DentalCAD
- 3Shape
- Exocad
- Dental Wings

Standard

System	Color	Diameter	Length	Type	Ref.C
AnyRidge	Gold	Ø10	20	Hex	ARTR1020.MTN
				Non-Hex	ARTR1020N.MTN
		Ø12		Hex	ARTR1220.MTN
				Non-Hex	ARTR1220N.MTN
AnyRidge Octa 1	Gold	Ø10		Hex	AROTGN1020.MTN
				Non-Hex	AROTGN1220.MTN
	Silver	Ø10		Hex	AROTGR1020.MTN
				Non-Hex	AROTGR1220.MTN
AnyOne Internal	Pink	Ø10	Hex	AOTR1020.MTN	
			Non-Hex	AOTR1020N.MTN	
		Ø12	Hex	AOTR1220.MTN	
			Non-Hex	AOTR1220N.MTN	
AnyOne External	N/A	Ø12	Hex	AETS1220.MTN	
			Hex	AETR1220.MTN	
			Hex	AETW1220.MTN	
MiNi	N/A	Ø10	Hex	MITN1020.MTN	
			Non-Hex	MITN1020N.MTN	
ST	Small	Ø10	Hex	OSTG3112.MTN	
			Non-Hex	OSTG3112N.MTN	
		Ø12	Hex	OSTG3111.MTN	
			Non-Hex	OSTG3111N.MTN	
	Regular	Ø10	Hex	OSTG3212.MTN	
			Non-Hex	OSTG3212N.MTN	
		Ø12	Hex	OSTG3211.MTN	
			Non-Hex	OSTG3211N.MTN	
Octa Level	Small	Ø10	Octa	OCTS1020.MTN	
			Non-Octa	NOTS1020.MTN	
		Ø12	Octa	OCTS1220.MTN	
			Non-Octa	NOTS1220.MTN	
	Regular	Ø10	Octa	OCTR1020.MTN	
			Non-Octa	NOTR1020.MTN	
		Ø12	Octa	OCTR1220.MTN	
			Non-Octa	NOTR1220.MTN	
	Wide	Ø10	Octa	OCTW1020.MTN	
			Non-Octa	NOTW1020.MTN	
		Ø12	Octa	OCTW1220.MTN	
			Non-Octa	NOTW1220.MTN	



Extra EZ Connection

System	Color	Fixture Core	Diameter	Length	Type	Ref.C		
AnyRidge	Gold	3.3	Ø10	20	Hex	ARTXN1020.MTN		
					Non-Hex	ARTXN1020N.MTN		
					Ø12	Hex	ARTXN1220.MTN	
						Non-Hex	ARTXN1220N.MTN	
					4.0	Ø10	Hex	ARTXM1020.MTN
							Non-Hex	ARTXM1020N.MTN
		Ø12	Hex		ARTXM1220.MTN			
			Non-Hex		ARTXM1220N.MTN			
		4.8	Ø10		Hex	ARTXL1020.MTN		
					Non-Hex	ARTXL1020N.MTN		
			Ø12		Hex	ARTXL1220.MTN		
					Non-Hex	ARTXL1220N.MTN		



Why will AnyRidge work in any ridge?

Narrow upper diameter

To maximize preservation by minimizing stress on the cortical bone.

XPEED®

- For faster, stronger osseointegration.
- New surface technology incorporating Ca²⁺ ions on the SLA treated surface.
- 100% elimination of any remaining acid from the conventional SLA process.

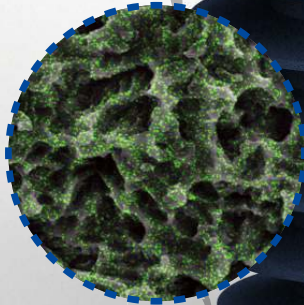

Wider fixture in a narrow CREST

To maximize long term survival of implants.

Knife-Threads

- For smooth insertion and stronger primary stability.
- No cutting edge for minimum invasion.
- Ideal for soft bone cases.

Tapered body

Excellent for simple installation and Immediate loading.

Narrow apical diameter

For easier fixture insertion into a narrow ridge split incision

Case1



Case2

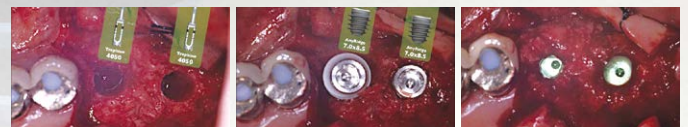

AnyRidge Clinical Case

➔ Clinical Case 1

- Courtesy of Dr. Kwang-Bum Park

AnyRidge implant has excellent surface treatment which can be osseointegrated at this extreme case of bone defect.

Fig 1. This patient was 56 years old male patient and had a chief complaint of chewing difficulty on the left first mandibular molar due to periodontitis. On the panoramic radiograph, the tooth was floated with complete bone loss to the apex, and there was not enough bone to get initial stability for implant placement at the apex above mandibular nerve. So I decided to extract the tooth and wait for 4 months for regeneration of the socket.



Fig 2. The patient came back to my office after 4 months. Healing appeared good enough clinically, but the panoramic view still showed large socket defect. In many cases like this, we can expect some amount of bone filled in the socket which can allow minimal initial stability for implant placement.

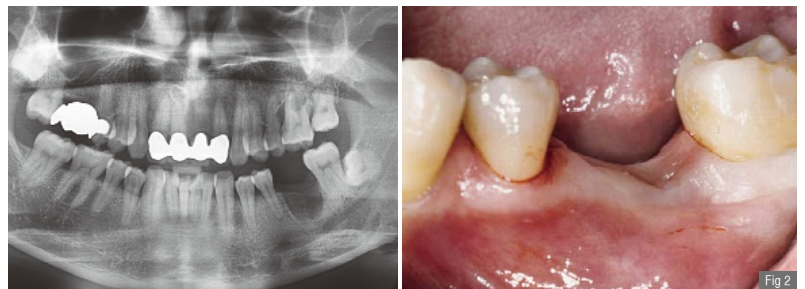

Fig 3. When the flap was opened, I was very embarrassed that bone regeneration did not occur in the socket. None of remaining bone could be used for implant fixation.



Fig 4. A widest AnyRidge implant 8.0mm was placed on the mesial wall of extraction socket, but there was no initial stability. This trial was quite heroic treatment, but there was no other option except this because he spent many hours for this surgery.



Fig 5. The mixture of Allograft (Mega-Oss) and Synthetic bone (Bone Plus) was placed into the remaining socket defect and a collagen membrane was covered. Then primary closure was made with incision release on the periosteum.

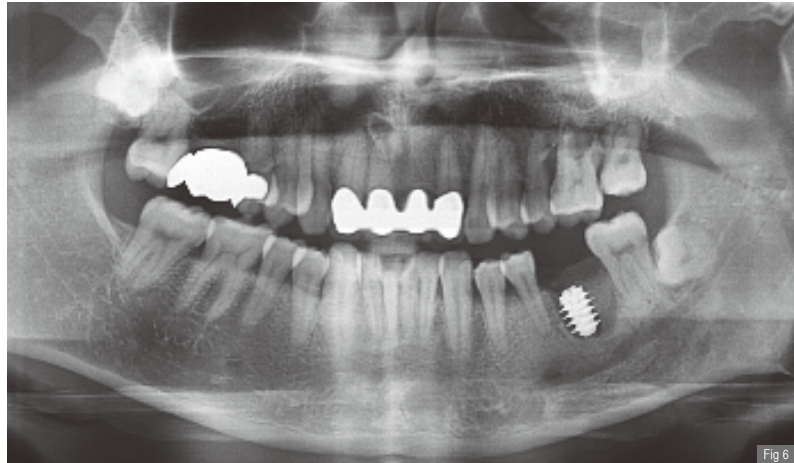

Fig 6. On the panoramic view after surgery, we could find that none of the fixture was engaged with remaining bone, so it had more than 1.6mm gap from the tip to the depth of knife threads. I worried about the bone filling and success of the osseointegration on this fixture.

Fig 7. However, I was surprised with the hard cortical bone regeneration over the cover screw when I did the second stage surgery with the Biolaser.

Fig 8. On the intraoral radiograph taken several weeks after second surgery, we could see the fully regenerated bone into the bottom of thread depth.

Fig 9. The patient came back to our office to get one more implant on the maxillary upper molar after 2 years from the first implant surgery. The regenerated bone was matured and showed very stable crestal bone on the intraoral radiograph.



➔ Clinical Case 2

- Courtesy of Dr. Kwang-Bum Park

Advantage of fuse abutment with AnyRidge implant for immediate loading in upper fully edentulous case

Fig 1. An 80-year-old female patient presented with discomfort related to her upper teeth. About 10 years previously she underwent implant surgery in the mandible and received temporary teeth immediately as the bone density was sufficient for immediate loading. The patient requested a treatment plan for the upper arch that would give her immediate teeth.

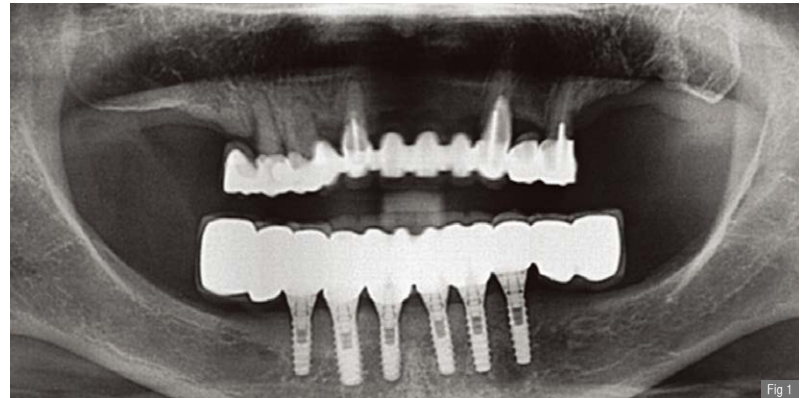

Fig 2. Clinical photos before surgery. The patient had no discomfort or complaints related to her mandibular implants. Plus her hygiene control was very good for maintaining healthy peri-implant tissue.



Fig 3. All the remaining teeth were extracted. As shown, some teeth had severe periodontitis and some had decay at the cervix of the tooth. Drilling up to 2.9 mm was conducted at each implant site and eight 3.5x15mm implant fixtures were placed using a minimal flap design. All the fixtures showed excellent initial fixation, and the immediately-placed implants only had small socket defects.



Fig 4. Eight fuse abutments were connected and the flaps were sutured to create a tight sealing against the fuse abutments



Fig 5. The fuse abutments were prepared using a high speed handpiece for a temporary bridge that was already made before the implant surgery

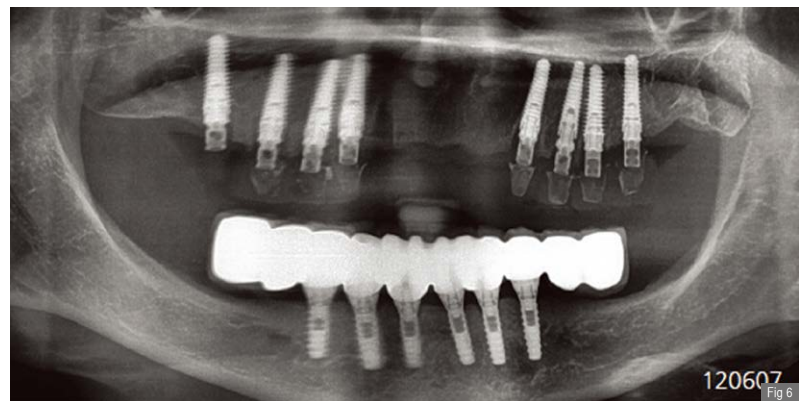
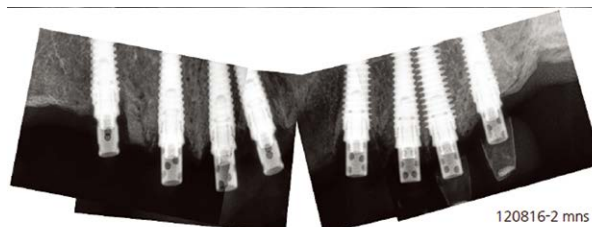

Fig 6. Panoramic scan taken immediately after surgery. The first premolar implant showed some mis-fit between the crown and the ratio.

Fig 7. Intraoral scans taken 2 months after surgery. Shadows of the extraction socket can still be seen, but regenerated bone has started to fill the socket defects. The fuse abutments are functioning well without any problem. An impression was taken for customized zirconia abutments



120816-2.mns

Fig 7

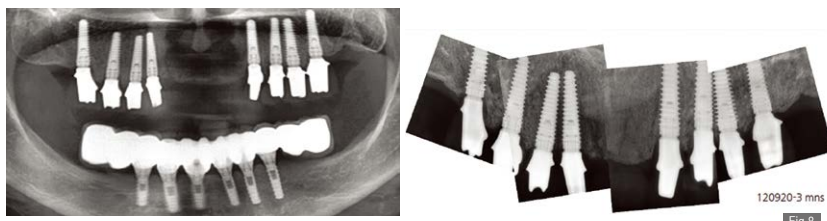

Fig 8. Panoramic & intraoral scans taken 3 months after surgery. Zirconia customized abutments were connected to each fixture. The socket defects are completely filled with regenerated bone even in the case of immediate loading on the immediately placed implants.



Fig 9. Clinical photos of zirconia customized abutments and PMMA temporary bridge made using CAD/CAM technique. A zirconia abutment is excellent for both esthetics and hygiene maintenance. It has less than 1/10 bacterial accumulation on the surface compared with metals including titanium. PMMA provisional bridge is stronger than tooth resin, especially at the margin, so much beneficial for functional and occlusal tests.



Fig 10. A full zirconia one-piece bridge was made and delivered. The patient was very satisfied with the results, and thankful that she was provided with 'teeth' from the beginning to the end.

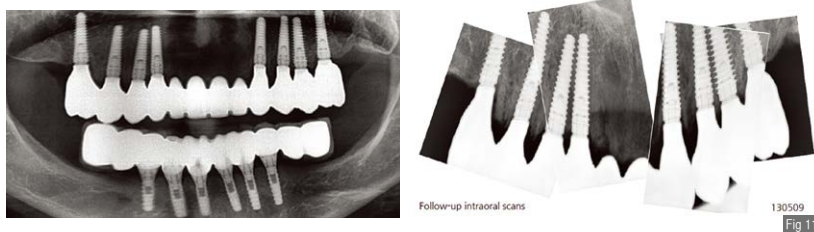
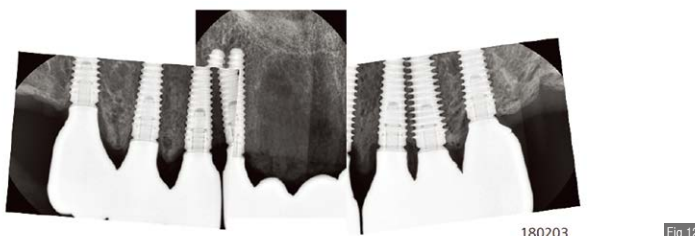
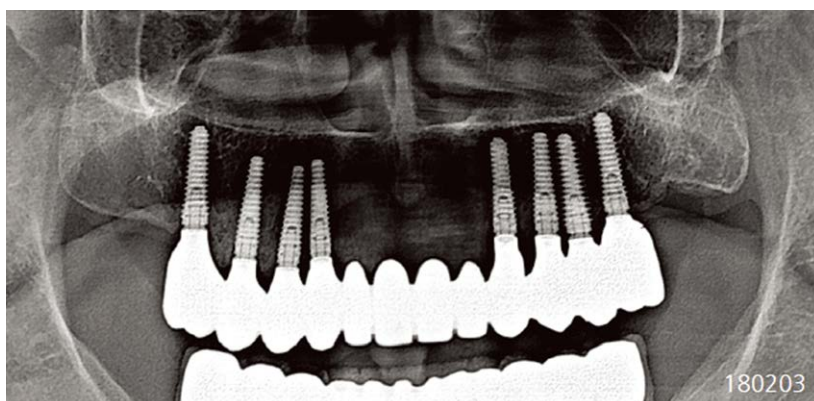

Fig 11. Panoramic scan of final restorations on day of delivery

Fig 12. Panoramic scans at 7 years follow-up



➔ Clinical Case 3

- Courtesy of Dr. Soheil Bechara

Simultaneous sinus lift and implant placement

Fig 1. The patient presented with huge bony defects around residual roots in the upper jaw. The treatment plan was to perform immediate implant placement and extract all decayed roots during one surgical session, as the patient had only one week to stay in the country.



Fig 2. Lateral window sinus lifting was performed on the right side with simultaneous implant placement in tooth area 17. In area 14 we can observe a huge bony defect which was thoroughly debrided until the margins of healthy bone. The Osteotomy was prepared with a 2mm final drill to place a 3.5x15mm Anyridge implant.



Fig 3. 3.5x15mm Anyridge implant was placed having only 2mm contact with the bone in the coronal part achieving 25 Ncm of initial torque.

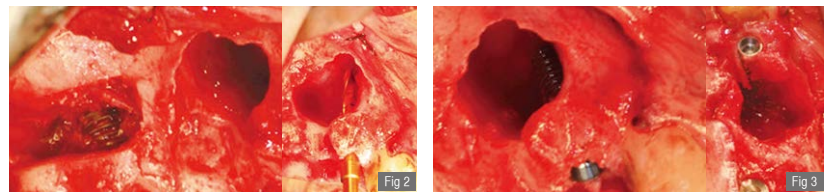

Fig 4. The bony defect was filled with a Xenograft and covered with a collagen membrane. Although the defect is huge but it is still considered as an intra-bony defect with a good potential of bone regeneration.

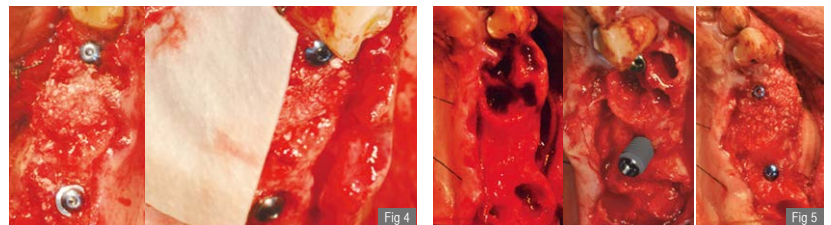
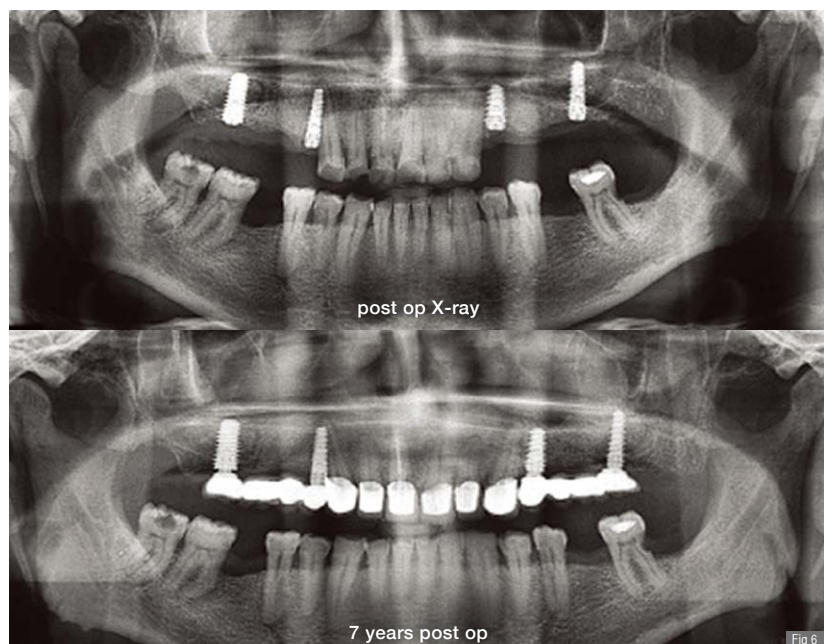

Fig 5. On the left side two Anyridge implants were placed, immediate implant placement in area 24. Sinus lift with simultaneous implant placement in area 27.



➔ Clinical Case 4

- Courtesy of Prof. Giuseppe Luongo

Immediate post-extraction insertion of implant and immediate loading.

Before Surgery

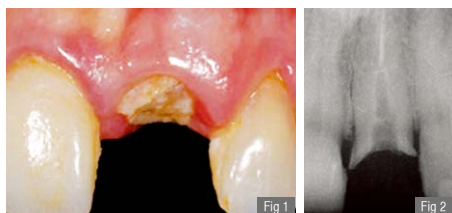

Fracture of #21 tooth. Good stability of the hard and soft tissues suggests immediate post-extraction insertion of implant and immediate loading.

Fig 1. Clinical photos.

Fig 2. Intraoral scan.

Fig 3, 4. Clinical photos of 1st surgery.

Fig 5, 6. Clinical photos of implant positioning.

Fig 7, 8. Clinical photo & scan of surgery.

Fig 9, 10. Clinical photos of immediate temporary crown in place.

Fig 11, 12. Clinical photos of healing and final abutment in place.

Fig 13. Clinical photo of zirconia framework in place.

Fig 14, 15. Clinical photo & intraoral scan of final crown at time of placement.

Fig 16, 17. Clinical photo & intraoral scan of final crown at 1-yr follow-up.

Fig 18, 19. Clinical photo & intraoral scan of final crown at 5-yr follow-up.

Surgery

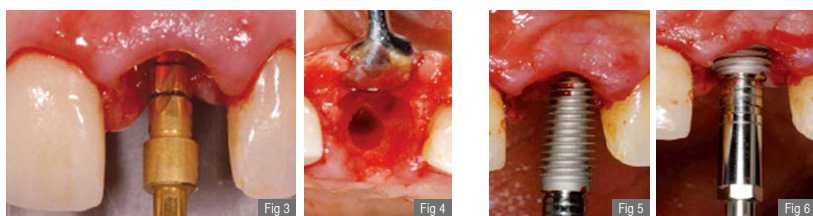

To protect the esthetic outcome of the procedure, the implant site was prepared via slightly palatal alveolar access.

A 4.5x11mm Anyridge was placed in the prepared site.

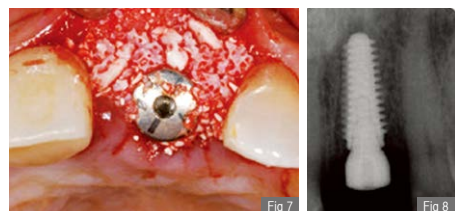

Biomaterial was added to the vestibular aspect to improve the stability of the esthetic outcome.

Temporary Prosthesis



A temporary crown was immediately placed.

12 Weeks after surgery

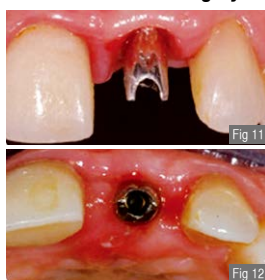

Tissue was ready to proceed with final abutment and crown.

Final Prosthesis



The implant position was in harmony with the surrounding tissue and a prosthodontist completed the case using a zirconia framework.

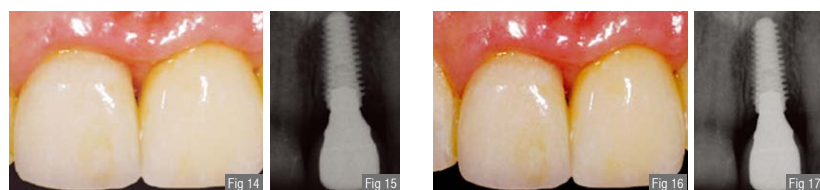



ANYRIDGE®
by MEGA!GEN



Head Office & Factory
Gangnam Office

45, Secheon-ro 7-gil, Dasa-eup, Dalseong-gun, Daegu, Korea
MegaGen Tower, 607 Seolleung-ro, Gangnam-gu, Seoul, Korea

T. +82-1544-2285
T. +82-1566-2338